



QCEC

“Dependability Defined”

All-Season CVE-16 ***Refrigerated Wastewater Samplers*** ***Optima, Premium and Dual Models*** ***Composite and Sequential***



Operations and Maintenance Manual

Rev. A, February 2018

Part Number: 69-2303-211



TELEDYNE ISCO
Everywhereyoulook™

4700 Superior Street • Lincoln, NE 68504
(402) 464-0231 • (800) 228-4373
www.teledyneisco.com • isco.info@teldeyne.com

August 2017

TO: Purchaser of QCEC Brand Products

FROM: Teledyne ISCO

We hope that you find this recent product purchase meets your needs. We wanted to update you that the QCEC product you purchased is now manufactured by Teledyne ISCO and is backed by Teledyne ISCO's commitment to quality products and exceptional customer service.

Teledyne Isco, a world leader in automatic water sampling and open channel flow monitoring products, acquired in late April 2017 the QCEC line of water & wastewater automatic samplers and flowmeters. With the addition of this sampling vacuum pump technology, we are able to offer a broader sampler product offering to meet customers' needs.

Teledyne Isco has been in business for over 50 years manufacturing a wide range of products for professionals working in water pollution monitoring and abatement, engineers and managers involved with wastewater process control, and scientists involved in field and laboratory work. We take pride in the fact that the products we produce are used by our customers to improve the quality of life on Earth.

We offer all our customers responsive, competent, and excellent service and support. Our customers are the most important part of our business, and we work tirelessly to ensure your complete satisfaction. Provided below are key contact information so that you can reach us at your convenience.

Water & Wastewater Product Support:

| | |
|-----------------|----------------------|
| Telephone | (402) 853-5350 |
| Toll Free (USA) | (866) 298-6174 |
| Email | IscoEPS@teledyne.com |

Teledyne ISCO
4700 Superior Street
PO Box 82531
Lincoln, NE 68501

| | |
|---------------------------|--|
| Telephone | (402) 464-0231 |
| Fax | (402) 464-0318 |
| Toll Free (USA) | (800) 228-4373 |
| Email information request | iscoinfo@teledyne.com |
| Website | www.teledyneisco.com |

Teledyne Isco Two Year Limited Factory Service Warranty*

This warranty exclusively covers Teledyne Isco instruments, providing a two-year limited warranty covering parts and labor.

Any instrument that fails during the warranty period due to faulty parts or workmanship will be repaired at the factory at no charge to the customer. Teledyne Isco's exclusive liability is limited to repair or replacement of defective instruments. Teledyne Isco is not liable for consequential damages.

Teledyne Isco will pay surface transportation charges both ways within the 48 contiguous United States if the instrument proves to be defective within 30 days of shipment. Throughout the remainder of the warranty period, the customer will pay to return the instrument to Teledyne Isco, and Teledyne Isco will pay surface transportation to return the repaired instrument to the customer. Teledyne Isco will not pay air freight or customer's packing and crating charges. This warranty does not cover loss, damage, or defects resulting from transportation between the customer's facility and the repair facility.

The warranty for any instrument is the one in effect on date of shipment. The warranty period begins on the shipping date, unless Teledyne Isco agrees in writing to a different date.

Excluded from this warranty are normal wear; expendable items such as desiccant, pH sensors, charts, ribbon, lamps, tubing, and glassware; fittings and wetted parts of valves; check valves, pistons, piston seals, wash seals, cylinders, pulse damper, diaphragms, inlet lines and filter elements, and damage due to corrosion, misuse, accident, or lack of proper maintenance. This warranty does not cover products not sold under the Teledyne Isco trademark or for which any other warranty is specifically stated.

No item may be returned for warranty service without a return material authorization number issued by Teledyne Isco.

This warranty is expressly in lieu of all other warranties and obligations and Teledyne Isco specifically disclaims any warranty of merchantability or fitness for a particular purpose.

The warrantor is Teledyne Isco, 4700 Superior, Lincoln, NE 68504, U.S.A.

*** This warranty applies to the USA and countries where Teledyne Isco does not have an authorized dealer. Customers in countries outside the USA, where Teledyne Isco has an authorized dealer, should contact their Teledyne Isco dealer for warranty service.**

Before returning any instrument for repair, please call, fax, or e-mail the Teledyne Isco Service Department for instructions. Many problems can often be diagnosed and corrected over the phone, or by e-mail, without returning the instrument to the factory.

Instruments needing factory repair should be packed carefully, and shipped to the attention of the service department. Small, non-fragile items can be sent by insured parcel post. **PLEASE BE SURE TO ENCLOSE A NOTE EXPLAINING THE PROBLEM.**

Shipping Address: Teledyne Isco - Attention Repair Service
4700 Superior Street
Lincoln, NE 68504 USA

Mailing Address: Teledyne Isco
PO Box 82531
Lincoln, NE 68501 USA

Phone: Repair service: (800) 775-2965 (lab instruments)
(866) 298-6174 (samplers & flow meters)
Sales & General Information: (800) 228-4373 (USA & Canada)

Fax: (402) 465-3001

Email: IscoService@teledyne.com



January 10, 2017 P/N 60-1002-041

Table of Contents

| | |
|--|----|
| Warranty | 2 |
| Table of Contents..... | 3 |
| List of Illustrations | 6 |
| List of Tables..... | 6 |
| Configuration Quick Start..... | 7 |
| Composite Sample Storage..... | 9 |
| Sequential Sample Storage | 10 |
| Operation Quick Start | 12 |
| Chapter 1: Introduction..... | 13 |
| 1.1: Revision Notes | 13 |
| 1.2: Physical Description..... | 15 |
| 1.2.1: Temperature Control System | 15 |
| 1.2.2: Sample Collection System..... | 15 |
| 1.2.3: Sample Storage System..... | 16 |
| 1.2.4: Sampling Control System..... | 16 |
| 1.2.4.1: User Interface Panel..... | 17 |
| 1.2.4.2: Inputs and Outputs | 17 |
| 1.3: Sampling Programs | 18 |
| Chapter 2: Installation..... | 19 |
| 2.1: Positioning Considerations..... | 19 |
| 2.1.1: Hydrogen Sulfide Exposure..... | 19 |
| 2.2: Sampling Line Connection | 20 |
| 2.3: Sample Size Adjustment..... | 21 |
| 2.3.1: Velocity Valve Adjustment..... | 21 |
| 2.4: Field I/O Connections..... | 22 |
| 2.4.1: Flow Inputs..... | 22 |
| 2.4.2: Relay Outputs | 23 |
| 2.4.3: Float Inputs..... | 23 |
| Chapter 3: User Interface Panel..... | 24 |
| 3.1: Menu System..... | 25 |
| 3.2: Administration Menu | 27 |
| 3.2.1: Administration Password..... | 27 |
| 3.2.2: Clock Settings..... | 29 |
| 3.2.3: LCD Brightness | 30 |
| 3.2.4: Archival Data Administration | 31 |
| 3.2.5: Set ID Number..... | 32 |
| 3.2.6: Set Volumetric Units | 32 |
| Chapter 4: Sampling Program Configuration..... | 33 |
| 4.1: Program Selection | 33 |
| 4.2: Program Configuration Groups | 34 |
| 4.3: Sampling Cycle Settings..... | 35 |
| 4.3.1: Pre-Sampling Purge Duration | 35 |
| 4.3.2: Sampling Time | 36 |
| 4.3.3: Post-Sampling Purge Duration..... | 36 |
| 4.3.4: Line Conditioning Rinses..... | 37 |

| | | |
|------------|--|----|
| 4.3.5: | Incomplete Sample Recycling..... | 38 |
| 4.3.6: | Consecutive Sampling..... | 38 |
| 4.4: | Sampling Intervals..... | 39 |
| 4.4.1: | Timed Interval Sampling..... | 40 |
| 4.4.1.1: | Fixed Length Time Intervals..... | 40 |
| 4.4.1.2: | Variable Length Time Intervals..... | 41 |
| 4.4.2: | Flow Interval Sampling..... | 42 |
| 4.4.2.1: | Analog Flow Input..... | 43 |
| 4.4.2.1.1: | Fixed Volume Flow Intervals..... | 44 |
| 4.4.2.1.2: | Variable Volume Flow Intervals..... | 44 |
| 4.4.2.2: | Pulsing Flow Input..... | 45 |
| 4.4.2.2.1: | Fixed Pulses Flow Intervals..... | 45 |
| 4.4.2.2.2: | Variable Pulses Flow Intervals..... | 46 |
| 4.4.3: | Time+Flow Interval Sampling..... | 46 |
| 4.4.4: | Per-Bottle Timed Interval Sampling..... | 47 |
| 4.4.5: | Per-Bottle Flow Interval Sampling..... | 48 |
| 4.5: | Bottle Options..... | 48 |
| 4.5.1: | Composite Sample Containers..... | 49 |
| 4.5.1: | Discrete/Sequential Sample Containers..... | 50 |
| 4.5.1.1: | Bottle Indexing Options..... | 51 |
| 4.5.1.1.1: | After Time Indexing..... | 52 |
| 4.5.1.1.2: | Real Time Indexing..... | 52 |
| 4.6: | Program Run Options..... | 53 |
| 4.6.1: | Automatic Rerun..... | 53 |
| 4.6.2: | Delayed Start..... | 54 |
| 4.6.3: | Fault Option..... | 54 |
| 4.6.4: | Float Option..... | 55 |
| 4.6.5: | Timed Stop..... | 55 |
| 4.6.6: | Bottle Limit Override..... | 56 |
| 4.7: | Program Events..... | 57 |
| 4.7.1: | Reviewing Scheduled Events..... | 57 |
| 4.7.2: | Adding and Editing Events..... | 58 |
| 4.7.3: | Deleting Events..... | 60 |
| 4.7.4: | Disabling Events..... | 61 |
| Chapter 5: | Sampler Operation..... | 62 |
| 5.1: | Ready State..... | 63 |
| 5.2: | Sampler Conditions..... | 64 |
| 5.3: | Starting the Selected Program..... | 64 |
| 5.3.1: | Timed-Delay Starting..... | 64 |
| 5.3.2: | Float-Delayed Starting..... | 65 |
| 5.3.3: | Timed Starting..... | 65 |
| 5.3.3.1: | Timed State..... | 66 |
| 5.3.4: | Scheduled Starting..... | 66 |
| 5.4: | Running State..... | 67 |
| 5.4.1: | Sampling Intervals..... | 68 |
| 5.4.2: | Sample Container Screens..... | 68 |
| 5.4.3: | Sampling Cycle..... | 69 |

| | | |
|-------------|--|----|
| 5.4.3.1: | Incomplete Sample Recycling..... | 70 |
| 5.4.3.2: | Manual Sampling..... | 70 |
| 5.5: | Paused and Halted States..... | 71 |
| 5.5.1: | Float Suspended Sampling..... | 72 |
| 5.6: | Stopping the Program..... | 73 |
| 5.6.1: | Continuous Operation..... | 73 |
| 5.7: | Reviewing Archived Data..... | 74 |
| Chapter 6: | Maintenance..... | 77 |
| 6.1: | Routine Maintenance..... | 77 |
| 6.1.1: | Cleaning the Sampler..... | 77 |
| 6.1.2: | Verifying the Temperature..... | 77 |
| 6.2: | Refrigeration System Maintenance..... | 78 |
| 6.2.1: | Adjusting the Thermostat..... | 79 |
| 6.2.2: | Refrigeration Module Removal..... | 80 |
| 6.2.3: | Refrigeration Module Installation..... | 80 |
| 6.3: | Compression/Vacuum Pump..... | 81 |
| 6.4: | Control System Fuse..... | 82 |
| 6.5: | Optional 240-120 VAC Transformer..... | 82 |
| 6.6: | Troubleshooting Tips..... | 83 |
| Appendix A: | Controller Capabilities..... | 85 |
| A.1: | Overview..... | 85 |
| A.1.1: | Supervisory Routine (Ready State)..... | 85 |
| A.1.2: | Menu System Outline..... | 86 |
| A.2: | Inputs and Outputs..... | 88 |
| A.2.1: | Run-Status Output..... | 88 |
| A.2.2: | Alarm Output..... | 88 |
| A.2.3: | Turntable I/O..... | 88 |
| A.2.4: | Temperature Input..... | 89 |
| A.2.5: | Flow Inputs..... | 89 |
| A.2.5.1: | Remote Sample Initiation..... | 89 |
| A.2.6: | Float Input..... | 90 |
| A.2.6.1: | Factory Menu Float Setting..... | 90 |
| A.2.7: | Liquid Sensor..... | 91 |
| A.2.8: | Sampling Outputs..... | 91 |
| A.3: | Sampling Program..... | 92 |
| A.3.1: | CVE-16 Sampling Cycle..... | 92 |
| A.3.1.1: | Sample Recycling..... | 93 |
| A.3.2: | Sampling Intervals..... | 94 |
| A.3.2.1: | Variable Intervals..... | 94 |
| A.3.3: | Bottle Options..... | 95 |
| A.3.3.1: | Composite Sampling..... | 95 |
| A.3.3.2: | Sequential Sampling..... | 96 |
| A.3.3.2.1: | After-Bottle Indexing..... | 96 |
| A.3.3.2.2: | After-Sample Indexing..... | 96 |
| A.3.3.2.3: | After-Time Indexing..... | 97 |
| A.3.3.2.4: | Real-Time Indexing..... | 97 |
| A.3.3.3: | Per Bottle Sampling..... | 98 |

| | |
|-------------------------------------|-----|
| A.3.3.4: Duplicate Sampling..... | 98 |
| A.3.4: Delayed Starting..... | 99 |
| A.3.5: Timed Stopping..... | 99 |
| A.3.6: Scheduled Events | 100 |
| A.3.7: Data Archiving..... | 101 |
| Appendix B: Replacement Parts | 102 |
| Appendix C: Specifications | 107 |

List of Illustrations

| | |
|---|-----|
| Figure 1-1: Interior of Composite Optima CVE-16 Sample Compartment..... | 14 |
| Figure 1-2: Sequential-Sampling Turntable and 24-bottle Carousel..... | 16 |
| Figure 1-3: Location of User Interface Panel..... | 17 |
| Figure 2-1: Flow Input Connections..... | 22 |
| Figure 2-2: Relay Output and Float Input Connections..... | 23 |
| Figure 3-1: User Interface Panel..... | 24 |
| Figure 6-1: All-Weather Sampler Refrigeration Module..... | 78 |
| Figure 6-2: Refrigeration Module Thermostat..... | 79 |
| Figure 6-3: Optima Sampler Pump Compartment | 81 |
| Figure 6-4: Quick-Lift Compressor/Vacuum Pump and Service Kit..... | 81 |
| Figure 6-5: Control system fuse holder in open and tripped positions..... | 82 |
| Figure A-1: CVE-16 Sample Chamber Pressure Sequencing..... | 91 |
| Figure A-2: CVE Sampling Cycle | 92 |
| Figure A-3: Basic Sample Timing Diagram | 94 |
| Figure B-1: CVE-16 Sample Chamber Parts..... | 104 |

List of Tables

| | |
|---|-----|
| Table 5-1: User Interface Panel and Icons | 62 |
| Table A-1: Available Program Event Types..... | 100 |
| Table B-1: Electrical System Parts..... | 102 |
| Table B-2: Temperature Control System Parts | 102 |
| Table B-3: Sampling Control System Parts..... | 103 |
| Table B-4: Vacuum/Pressurization System Parts..... | 103 |
| Table B-5: Intake Line Parts..... | 105 |
| Table B-6: Sample Chamber Parts..... | 105 |
| Table B-7: Sequential Turntable and Carousel Parts..... | 106 |
| Table B-8: Sample Containers and Bottles..... | 106 |

Configuration Quick Start

The following sample procedure would configure a CVE-16 sampler's program 1 to collect samples at 20 minute intervals:

1. Power up the sampler to display its Program 1 READY screen, then press F3 three times to access that program's sampling Cycle settings:



2. Press F3 again to display the PREPURGE setting. Then type the number of seconds the sample chamber should be pressurized to clear the intake prior to each sample (e.g., 20):

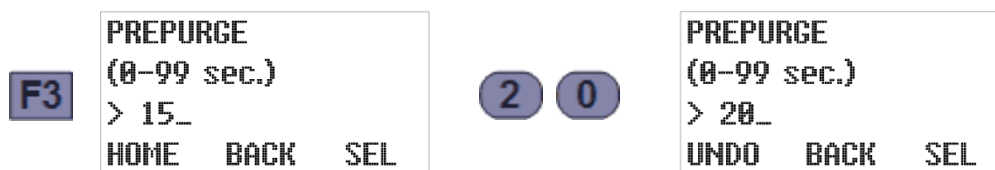

3. Press F3 to accept that Prepurge duration and view the SAMPLE SECONDS. Then type the number of seconds the sample chamber should be depressurized to fill it with wastewater (e.g., 45):

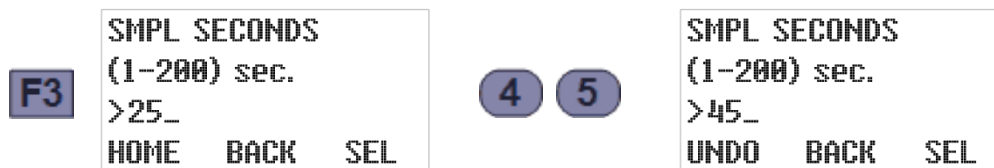

4. Press F3 to accept that setting and view the POSTPURGE time. Then type the number of seconds the chamber should be pressurized to clear the intake after each sample (e.g., 18):

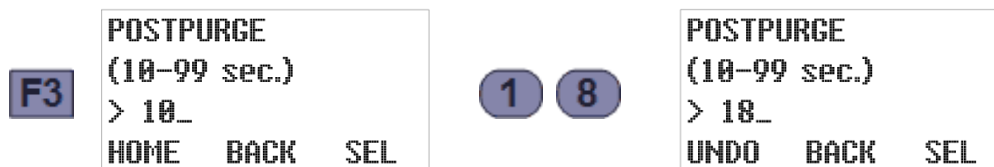

5. Press F3 to accept that setting and view the number of times the intake line should be rinsed prior to each sample. Then type the desired NUMBER of RINSES (e.g., 2):



6. Press F3 to accept that setting. If it is not zero, the rinse cycle PRESSURE TIME will then be displayed. Then type the number of seconds each rinse should pressurize the sample chamber (e.g., 8):



7. Press F3 to accept that setting and view the rinse cycle VACUUM TIME. Then type the number of seconds each rinse should suction in wastewater (e.g., 6):



8. Press F3 to accept that setting and view the RECYCLE setting. Then type 0 to disable or 1 to enable the incomplete sample retry feature:



9. Press F3 to accept that setting and view the CONSECUTIVE SAMPLING setting. To draw just one sample per interval, type 1 (if necessary) to disable that feature:



10. Press F3 to accept that setting and return to the PROGRAM CONFIG menu:

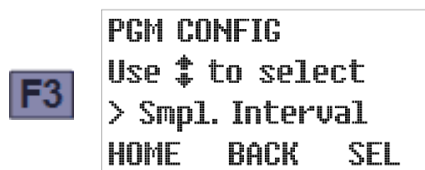

11. Press F3 to view the selected SAMPLING INTERVAL type. To change it, use the Up or Down key to scroll to the desired interval type (e.g., timed intervals):

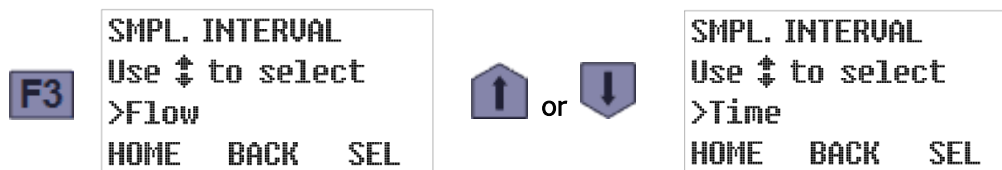

12. Press F3 to accept that setting and view its current TIME OPTION. To change it, use the Up or Down key to scroll to the desired option (e.g., fixed time intervals):

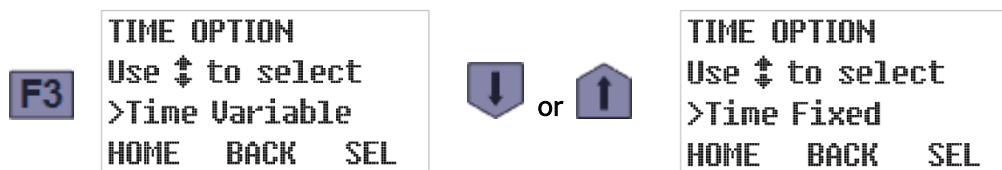

13. Press F3 to accept that option and view its current SAMPLE MINUTES setting. Then type the desired new interval length (e.g., 20 minutes):

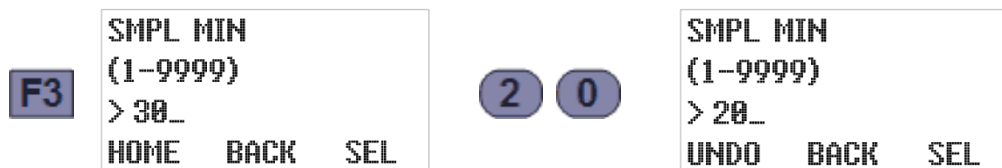

Composite Sample Storage

The following additional steps would configure a composite sampler to collect those samples for 16 hours, deposit all 48 of them into a 2.5-gallon container, and then stop:

14. Press F3 twice to accept that interval, return to the PROGRAM CONFIG menu, and display the installed SAMPLE STORAGE TYPE (composite or discrete/sequential):



It's possible but unlikely that pressing the Up or Down key would toggle that setting.

15. Press F3 to accept that setting and view the COMPOSITE SIZE setting. Then use the Up or Down key to scroll to the installed sample container size (e.g., 2.5 gallons):

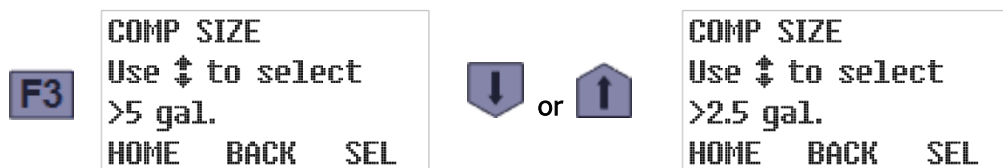

16. Press F3 to accept that setting and view the number of samples the container is currently set to receive. Then type the number of samples you want the program to collect (e.g., 48):

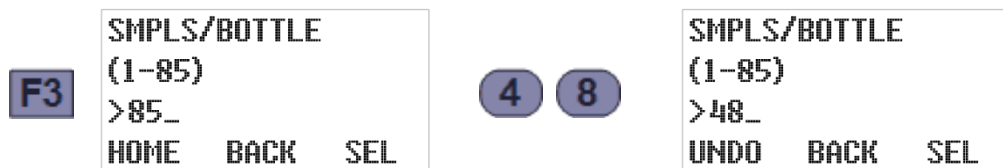

17. Press F3 to accept that setting and return to the PROGRAM CONFIG menu. Assuming you don't want to enable any PROGRAM RUN OPTIONS (which are all disabled by default), press F1 twice to display the PROGRAM READY screen:



18. Twenty minutes before the first sample is to be drawn, press F1 to start the sampling program. Barring unforeseen problems, that program would then run for 16 hours and stop:

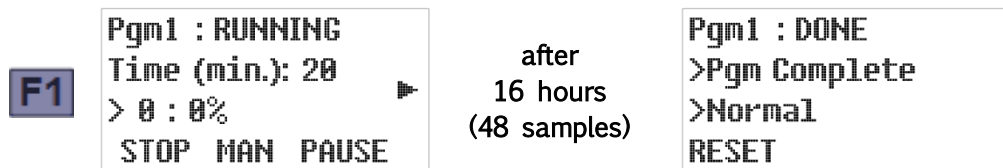

19. You should then replace the sample container with an empty one and press F1 to reset the program. Then repeat Step 19 twenty minutes before you want to start the next day's sampling.

Sequential Sample Storage

Alternately, the following steps would configure a sequential sampler to deposit each hour's three samples into a separate 1000 mL bottle, again stopping after 16 hours (48 samples):

14. Press F3 twice to accept the sampling interval, return to the PROGRAM CONFIG menu, and display the installed SAMPLE STORAGE TYPE (composite or discrete/sequential):



15. Press F3 to accept that setting and view the sequential BOTTLE CONFIGURATION. This is factory set to match the carousel you purchased, so you shouldn't need to change it. If you do, use the Up or Down key to scroll to the desired configuration:

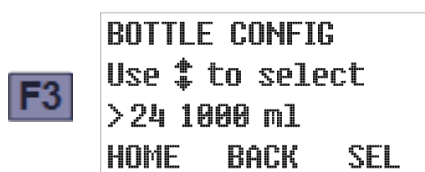

16. Press F3 to accept that setting and view the number of bottles the program is set to use (initially, it will usually indicate they will all be used). Use the numeric keys to change it to the number of bottles you want to use (16 in this example):



17. Press F3 to accept that setting and view the number of samples each container is currently set to receive. Then type the number that should be discharged to each bottle (e.g., 3):



18. Press F3 to accept that setting and view the the bottle indexing option the program is currently set to use. If necessary, use the Up or Down key to scroll to the desired option. In this example, we would select the After Bottle setting so the program would discharge three samples to each bottle and then rotate to the next:

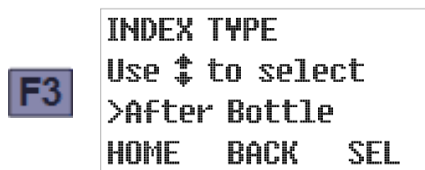

19. Press F3 to accept the After Bottle option, which will return you to the PROGRAM CONFIG menu. Assuming you don't want to enable any PROGRAM RUN OPTIONS (which are all disabled by default), press F1 twice to display the PROGRAM READY screen:

| | | | |
|-----------|---|---------------------|---|
| F3 | PGM CONFIG Use ↓ to select >Pgm. Run Opts. HOME BACK SEL | F1 F1 | Pgm1 : READY Time (min.): 20 > 0 : 0% RUN TIMED MENU |
|-----------|---|---------------------|---|

20. Twenty minutes before the first sample is to be drawn, press F1 to start the sampling program. Barring unforeseen problems, that program would then run for 16 hours and stop:

| | | | |
|-----------|---|-----------------------------------|--|
| F1 | Pgm1 : RUNNING Time (min.): 20 > 0 : 0% STOP MAN PAUSE | after 16 hours (48 samples) | Pgm1 : DONE >Pgm Complete >Normal RESET |
|-----------|---|-----------------------------------|--|

21. You should then replace the sample carousel with one containing empty bottles and press F1 to reset the program. Then repeat Step 20 twenty minutes before you want to start the next day's sampling.

Operation Quick Start

When powered up, the controller first displays one of its Ready screens (see page 63). All you need to do is start the indicated sampling program by pressing the RUN [F1] key:

| | | | |
|----------------------|--|---|--|
| sampler powers up | <pre>Pgm1 : READY Time (min.): 60 > 0 : 0% RUN TIMED MENU</pre> | <div style="border: 1px solid black; padding: 2px; display: inline-block;">F1</div> | <pre>Pgm1 : RUNNING Time (min.): 60 > 0 : 2% STOP MAN PAUSE</pre> |
| | | | |

The indicated time or flow interval counter will then accumulate until it reaches 100 percent of its target value, at which time the sampling cycle will be initiated (see page 69):

| | | | |
|-----------------------------|---|----|--|
| interval reaches 100% | <pre>SAMPLING rinse press... sec: 14 STOP</pre> | or | <pre>SAMPLING prepurge... sec: 12 STOP</pre> |
| | | | |

After the sample has been discharged to its storage container, the previously-displayed Running screen will reappear. The program will continue running until the specified number of samples has been collected, then stop and display its DONE screen. Alternately, you can manually stop it at any time by pressing the STOP [F1] key:

| | | | |
|--------------------------------------|--|--|---|
| after last sample is collected | <pre>Pgm1 : DONE >Pgm Complete >Normal RESET</pre> | OR <div style="border: 1px solid black; padding: 2px; display: inline-block;">F1</div> | <pre>Pgm1 : STOPPED >Pgm Stopped >From Keypad RESET</pre> |
| | | | |

In either case, the program's sample counters must then be reset (by pressing the RESET [F1] key) before another round of sampling can be initiated. Before doing so, remove the samples and install an empty container or bottle carousel.

The unit's operation can be further simplified by setting the Bottle Limit option (see page 56) to "Program Continue". The program would then continue sampling indefinitely, without requiring anyone to ever press the RESET [F1] key.

As the program would then have no way of knowing how many samples it has discharged since the container was last emptied, the sample count screen (see page 68) merely indicates "NL" (no limit). However, a composite sampler equipped with a bottle-full float switch would suspend its interval counters (and display a downward-pointing float icon) if that switch ever opened, then restart them from zero as soon the container was replaced (thus reclosing the switch):

| | | | |
|--|---|--|--|
| | <pre>Pgm1 : RUNNING Smp1#:NL 12:34:56 07/08/15 STOP MAN PAUSE</pre> | if composite container filled up | <pre>Pgm1 : RUNNING Time (min.): 60 > 0 : 0% STOP MAN PAUSE</pre> |
| | | | |

Chapter 1: Introduction

All-Season CVE-16 Samplers collect constant volume wastewater samples at programmed time or flow intervals and deposit them into refrigerated composite- or sequential-sample containers. Their vacuum pumps provide long-term consistent sampling with vertical lifts of up to 23 feet (28 feet with the quick-lift pump option), with no need to frequently replace the internal tubes that render peristaltic pumps inconsistent, unreliable and costly to maintain.

All-Season Samplers are available in three different configurations, each of which uses either the all-fiberglass Optima cabinet or the slightly larger Premium cabinet:

- The slightly-larger Premium Sampler has a stainless-steel lower shell and can accommodate any of our composite or sequential sample container systems.
- Dual Samplers house two independent sampling systems in a single Premium cabinet, but both cannot be equipped with large-container sequential carousels (two 24 x 500 milliliter carousels will fit, or one 24 x 500 ml carousel paired with any composite container).
- The slightly-smaller Optima cabinet has a fiberglass lower shell, which can accommodate all but the largest of our sample container systems (the 4 x 2 ½ gallon carousel will not fit, not will the 2 x 5 gallon carousel).

If you have any questions or suggestions, feel free to call QCEC at 1-515-266-2268 and ask for wastewater sampling technical support.

1.1: Revision Notes

The primary difference between the CVE-16 Sampling System and its CVE-12 predecessor is its new sample chamber, which is equipped with two electrodes the controller uses to determine when that chamber is full (see Liquid Sensor on page 91). So, like our QLS Samplers, CVE-16 units can be configured to repeat the rinse, prepurge and vacuum stages of the sample cycle up to four times in the event that a line blockage or other problem prevents the chamber from filling on the first try.

If you are familiar with the CVE-12 system, read the following sections to understand those changes:

- Section A.3.1 (CVE-16 Sampling Cycle), along with A.2.7 (Liquid Sensor) and Figure A-1., describe and illustrate the CVE-16 sampling cycle.
- Figure B-1 presents an exploded view of the new top-feed sample chamber.
- Section 2.3 (Sample Size Adjustment) tells how to adjust that chamber's sample size.
- Sections 4.3.5 (Sample Recycling) and 5.4.3.1 (Incomplete Sample Recycling) tell how to configure and monitor the recycle feature.

In addition, All-Season CVE-16 Samplers manufactured since late March of 2016 record time-stamped sampling data you can review from the user interface panel at virtually any time (see Reviewing Archived Data on page 74).

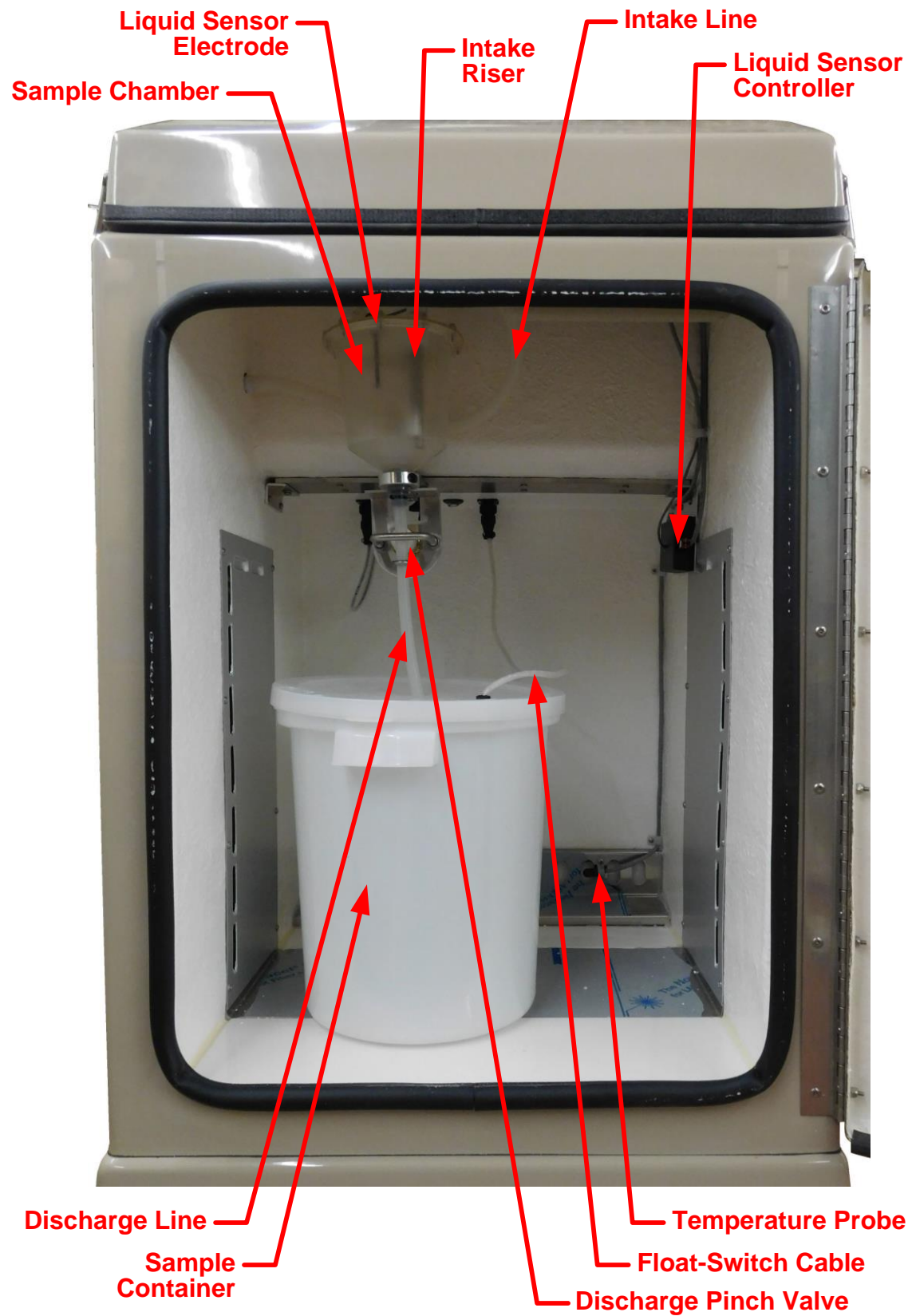

Figure 1-1: Interior of Composite Optima CVE-16 Sample Compartment

1.2: Physical Description

The components of each All-Season CVE-16 Sampler are mounted in a two-part housing designed to withstand corrosive conditions and outdoor weather:

- The insulated, temperature-controlled fiberglass upper shell houses the sample collection, sampling control and sample storage systems.
- The (fiberglass or stainless steel) lower shell houses the temperature control system.

1.2.1: Temperature Control System

The lower shell houses a refrigeration module with a digital thermostat and optional cold-climate heating element. It draws air from the back of the sample compartment, measures its temperature as it enters the module, cools (or heats) it, and then returns it via ducts in the floor and sides of the upper shell:

- The thermostat is factory set to maintain the stored samples at $4\pm 1^{\circ}\text{C}$ ($38\pm 2^{\circ}\text{F}$), but that set point can be changed if a different temperature is desired or if the actual temperature drifts due to calibration errors (see Adjusting the Thermostat on page 79).
- The refrigeration module can be removed for servicing through an access panel on the back of the lower shell (see Refrigeration System Maintenance on page 78).

1.2.2: Sample Collection System

Each Optima and Premium Sampler has a single sample collection system, while the Dual Model is equipped with two. That system includes the following major components:

- A clear plastic **sample chamber** with an adjustable wastewater inlet tube (whose projection into the chamber determines the sample size) and a discharge-tube **pinch valve**.
- A **liquid sensor** the controller uses to determine when the chamber is full.
- A 120 VAC piston **air compressor/vacuum pump** that connects to that chamber through a four-way **solenoid valve** (which alternately evacuates and pressurizes the sample chamber).
- A pump discharge pressure regulator and intake velocity-limiting valve.
- A 3/8 inch clear plastic **sampling tube** that extends to the sampled wastewater stream.

Each sample is collected by:

1. Blowing air through the chamber to clear the intake.
2. Sucking water into the chamber until it triggers the liquid sensor.
3. Blowing any water that is above the bottom of the intake tube back out through the inlet.
4. Opening the discharge valve to drain the remaining water into the sample container.

The sample chamber and velocity-limiting valve are mounted in the **sample compartment**, which also houses the sample storage system, occupies most of the upper shell, and is accessed through the unit's front door.

The pump, solenoid valve and pressure regulator are mounted behind the upper-rear access panel, in a smaller **pump compartment** that also houses the electrical transformer(s) and fuse for the control system (see Figure 6-3 on page 81). That compartment can also be equipped with an optional thermostatically-controlled cold-climate heating element in order to minimize condensation in the lines connecting the pump to the sample chamber.

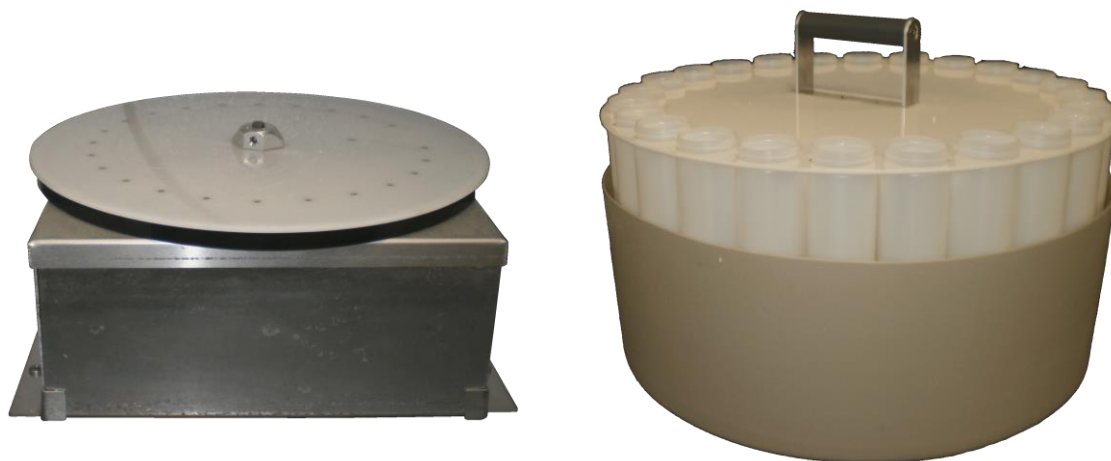

Figure 1-2: Sequential-Sampling Turntable and 24-bottle Carousel

1.2.3: Sample Storage System

All-Season CVE-16 Samplers can be purchased with either composite or sequential sample storage systems, which are installed in their sample compartments, accessed through their forward hatches, and can be supplied with a range of container options:

- **Composite-storage** systems deposit all samples into a single large container equipped with a liquid-level float that trips the sampling program when the container fills up.
- **Sequential-storage** systems have multiple sample bottles (usually two or twenty four) sitting in a turntable-mounted carousel, which are rotated under the sampling chamber and filled as specified by the sampling program.

Each program can be set to discharge one sample into each bottle, then a second sample into each, and so on—stopping after each bottle has received the specified number of samples; or the specified number of samples into the first bottle, the same number into the second bottle, and so on—stopping after the last bottle has been serviced.

⚠ *All composite samplers manufactured in 2016 (or later) are equipped with the internal cable connector needed to retrofit a sequential-sampling turntable.*

1.2.4: Sampling Control System

Each Optima and Premium Sampler has a single sampling controller, while the Dual Model is equipped with two. Each is mounted in a sealed **controller compartment** beneath the unit's user interface hatch, and includes **logic** and **power** circuit boards that collectively provide:

- a 32-bit microcontroller that can run any of six **sampling programs**
- a **backup battery** that powers the microcontroller's **real-time clock** but not its field elements (thus precluding continued sampling) when external power is unavailable
- the onboard **user interface**
- a variety of discrete and analog **inputs and outputs** (see next page)
- an **SDI-12 communication interface** for the CVE-16 liquid sensor
- the following communication ports (not yet implemented or unused by this model):
 - a USB-A **thumb drive** port (for archival data transfer)
 - USB-B and RS232 **Modbus ports**



Figure 1-3: Location of User Interface Panel

1.2.4.1: User Interface Panel

Each controller's heated LCD readout and password-protected keypad are located behind the sampler's upper-front hatch. They are used to:

- adjust the clock and the LCD brightness/contrast, and administer the access passwords and archival data (see Chapter 3: User Interface Panel);
- configure the sampling programs (see Chapter 4: Sampling Program Configuration); and
- monitor and control the unit's operation (see Chapter 5: Sampler Operation).

1.2.4.2: Inputs and Outputs

Each controller's logic board supports a variety of field input and output signals, some of which are wired directly to logic board connectors while others are routed through additional circuitry and connectors on the power board:

- All of the controller's required and optional inputs and outputs are described in detail in Appendix A (see page 88)
- Those circuits, and the circular plastic connectors (CPCs) to which the corresponding field devices must or can be wired, are shown on the Electrical Diagram appended to the back of this manual.
- Instructions for connecting your field devices to the controller's external CPCs are provided in Chapter 2 (see page 22).

1.3: Sampling Programs

Each control system provides six user-configurable sampling programs, one of which is selected and can be run at any given time. Each of those programs can be configured to:

- draw configurable, fixed-size (20 to 400 milliliter) samples, or sets of consecutive samples, at specified time or flow intervals.

Flow intervals can be based on either an analog or a discrete-pulse flow meter signal, or a PLC or other remote device could use the pulsing flow input to trigger individual samples.

- rinse the sampling line up to four times prior to drawing each sample.
- repeat any sampling cycle up to four times (five total) if needed to collect the desired volume of wastewater.
- discharge each sample into a specified sequential-sampling bottle (if so equipped).
- delay its execution a specified number of minutes after it is started, or until the optional float input is asserted.
- automatically stop after a configurable amount of time or number of samples.
- stop collecting samples when a composite-sampling bottle-full float switch opens, AND/OR

suspend and resume sampling as an optional external float switch opens and closes.

Alternately, a PLC or other remote device could use the external float-switch input to remotely suspend and resume the collection of samples.

- start sampling, pause or halt and later resume, take manual samples and finally stop at scheduled times on specified days of the week, then automatically restart itself if desired.
- energize a run-status relay to indicate a sample is being collected, or an alarm relay to indicate the program has stopped or encountered a fault condition.

Appendix A: Controller Capabilities discusses the configurable features of the sampling program, while Chapter 4: Sampling Program Configuration tells how to view and change the parameters that configure those features.

Chapter 2: Installation

All-Season Samplers are meant to be used in fixed locations, with any optional external I/O devices connected, the far ends of their sampling lines fixed in the waste streams they are to sample, and their power cords plugged into alternating-current power receptacles.

When you are ready to install your sampler:

1. Move it to its intended final location, remove its protective packaging, lift it from its shipping pallet and set it in its intended position.
2. Adjust the feet so the sampler is approximately level.
3. Install the wastewater intake line(s) and strainer(s).
4. Connect any external I/O devices (flow and/or float inputs, run and/or alarm outputs).
5. Plug the provided power cord into a grounded AC power receptacle.
6. Verify or correct the control system clock settings (see page 29).
7. Configure the sampling program(s) to your needs (see page 33).
8. Set the sample sizes by adjusting the chamber intake tubes (see next page)

2.1: Positioning Considerations

All-Season Samplers can be installed in nearly any indoor or outdoor locations, provided their vacuum pumps are less than 23 feet above the streams they will be sampling (28 if equipped with the optional quick-lift pump). Keep in mind that those pumps will be about 4 feet above the surface the sampler sits on.

You should provide at least 8 inches of clearance to each side of the cabinet (for cooling air flow and electrical and sampling line clearance). As little as 2 inches of rear clearance is sufficient, although servicing the refrigeration unit would then require you to move the unit forward to provide 3 feet of clear space. Anything mounted above your sampler should be at least 5 feet above the floor.

If lift trucks and/or other moving equipment are frequently operated in the selected area, you might want to install protective barriers to keep them from running into the sampler.

The unit is equipped with a grounded 9-foot 14/3 AWG power cord that exits the upper left rear corner of the cabinet 4 feet above the floor. If an AC receptacle is not located within reach of that cord, a sufficiently-long, customer-provided appliance-quality 15-amp extension cord will be needed.

2.1.1: Hydrogen Sulfide Exposure

Although the copper tubing in All-Season refrigeration units is coated to resist hydrogen sulfide (H_2S) corrosion, the high concentrations of that gas present in some areas of a wastewater treatment facility can still create pin-hole leaks after as little as a year or two of exposure. Therefore, you should select an installation location where the concentration of that gas is as low as possible. Because H_2S is heavier than air, high locations should be favored.

⚠ Refrigeration failures caused by excessive H_2S exposure are not covered by QCEC's standard two-year warranty.

2.2: Sampling Line Connection

The wastewater inlet connection is a 1/2 inch FNPT fitting recessed into the left side of the upper shell (Dual Models have one on each side). You can connect any appropriate plumbing materials, but the most common choice is 3/8 by 5/8 inch (I.D. by O.D.) clear PVC tubing connected using a right-angle barbed or compression fitting. Either fitting and needed length of tubing can be purchased from QCEC.

If you are using tubing and compression fittings obtained from QCEC:

1. Loosen (but do not remove) the compression nut.
2. Wet the end of the tubing and force it into the fitting as far as it will go.
3. Tighten the nut.

⚠ If you fully disassemble the fitting, there is a good chance the compression ring might fall out and be lost. Without it, you will be unable to obtain an airtight connection.

The far end of each tube is usually connected to an in-stream strainer, such as the stainless steel or PVC strainer available from QCEC. As shown to the right, both of them feature barbed fittings that the intake lines can be slipped over and clamped to.



2.3: Sample Size Adjustment

The CVE-16 sampling system collects uniform samples by suctioning wastewater into a sample chamber until it rises above the bottom of the intake tube, then blowing the excess back out. The size of those samples can thus be changed by adjusting how far that tube extends below the top of the sample chamber.

That tube extends down into the chamber through a compression fitting mounted in its lid. To adjust its extension into the chamber, repeat the following steps until the desired sample size is obtained:

1. Loosen the compression fitting nut.
2. Slide the tube farther down into or up out of the chamber.
3. Retighten the compression fitting nut.
4. Draw a manual sample and measure its volume.



⚠ *The sample size must be known to avoid setting the sampling programs to discharge more wastewater to the sample containers than they can hold.*

2.3.1: Velocity Valve Adjustment

If desired, you can slow the rate at which wastewater is drawn into the sample chamber by opening its velocity-limiting valve two or three turns. That valve is located above and behind the sample chamber, as shown to the right.



2.4: Field I/O Connections

Circular plastic connectors (CPCs) are mounted in the upper right side of Optima and Premium (and both sides of Dual) cabinets for the field I/O devices:

- a four-pin flow inputs connector (analog and/or pulsing-discrete signals)
- an optional seven-pin field I/O connector (alarm and run output and float input signals)

Custom cables must be fabricated (from the provided matching screw-terminal cable connectors) for any you chose to use.

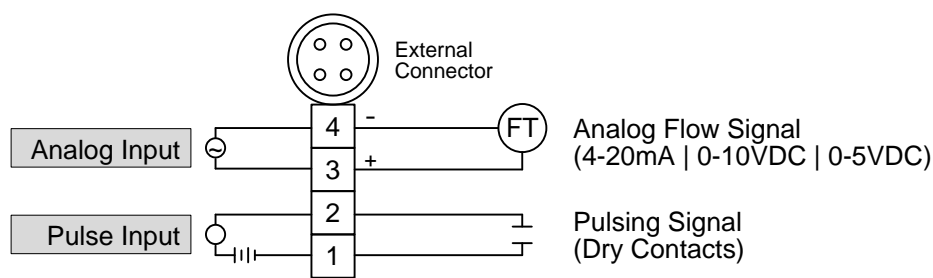

Figure 2-1: Flow Input Connections

2.4.1: Flow Inputs

The four-pin flow input connector provides field wiring terminals for pulse and analog flow input signals, either of which can be connected and used to trigger sample collection at configured stream flow intervals (see page 94):

- If that feature is configured for a pulsing input, connect a dry-contact signal source to input connector pins 1 and 2. The interval pulse count will be incremented each time that controller-powered circuit is externally closed.
- ✎ *To adapt this input to an externally-powered discrete signal, connect it to the normally-open contacts of an interposing relay and use that signal to energize the relay coil.*
- If that feature is configured for an analog flow signal, connect the transmitter's positive (+) and negative (-) terminals to input connector pins 3 and 4, respectively.

QCEC offers both an open-channel ultrasonic flowmeter (the QC-OC-1) and a closed-channel Doppler flowmeter (the QC-DT-1), both of which provide both analog and pulsing discrete flow outputs that satisfy the requirements of our wastewater sampler flow inputs.

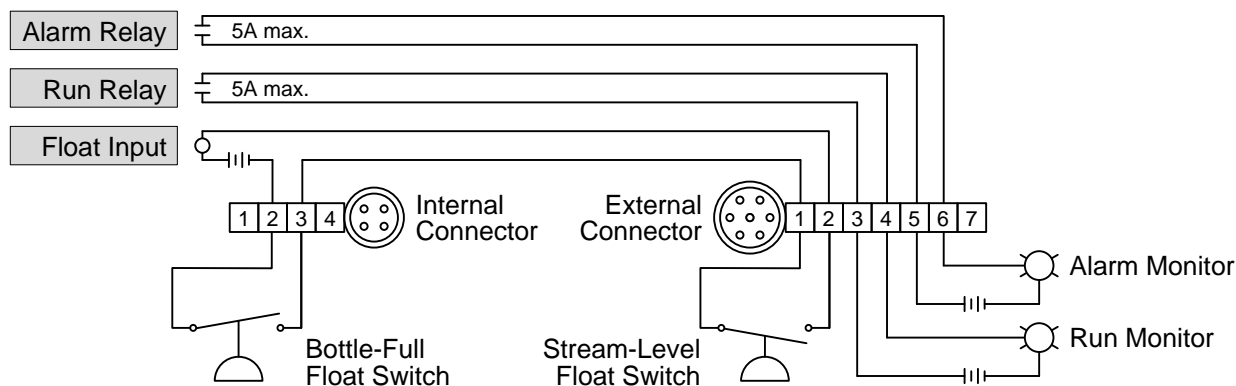

Figure 2-2: Relay Output and Float Input Connections

2.4.2: Relay Outputs

As shown above, four of the optional field I/O connector's seven pins connect to a pair of 5 Amp relay contacts on the controller's power board:

- the run-status relay connects pins 3 and 4 when the unit is sampling (see page 88)
- the alarm relay (if enabled) connects pins 5 and 6 when sampling is stopped or certain non-fatal fault conditions are detected (see page 88).

They can thus be used to turn appropriate *externally-powered* indicator lamps or annunciators on and off, or to signal those conditions to a SCADA or other host control system.

2.4.3: Float Inputs

Each CVE sampler is equipped with a four-pin float-switch connector mounted in the roof of its sample compartment and wired to the controller's Float input (as shown above). If your unit was purchased with a composite sample container, you should plug its bottle-full float switch into that connector and enable each sampling program's Float Option (see page 55).

If such a sampler is also equipped with the optional seven-pin field I/O connector, its first two pins are wired in series with the bottle-full switch (as shown above). As explained in the Float Input section on page 90:

- If a minimum-flow/stream-level float switch is connected across those terminals, samples are drawn only when both float switches are closed (or the Float Option is disabled).
- If no external float switch is connected, you will not be able to use the bottle-full feature unless you connect those external terminals with a jumper.
- If a sequential sampling carousel is installed, the bottle-full switch must either be moved out of the way, replaced by a cable connector with pins 2 and 3 jumpered, or unplugged (in which case the Float Option must be disabled).

⚠ *Due to the variety of suitable stream-level sensors that are available, QCEC neither recommends nor sells them—you must select and obtain one from a third-party supplier.*

Chapter 3: User Interface Panel

The sampler's operation can be configured, monitored and controlled using its user interface panel, which consists of a heated LCD readout and password-protected keypad located behind the upper-front door (Dual Samplers have two).

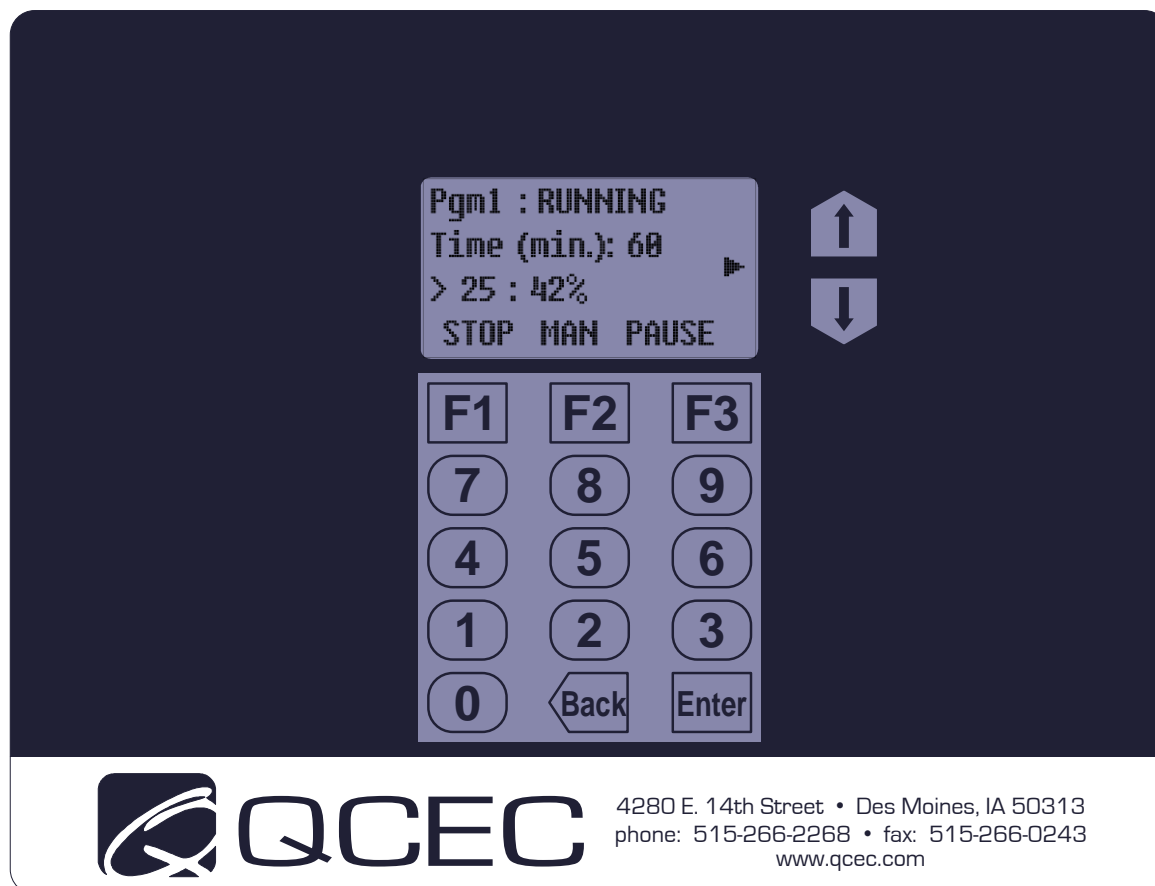

Figure 3-1: User Interface Panel

Its LCD readout displays the identity of the selected sampling program (see page 33), which the operator can start and stop or pause and resume. It displays four lines of alphanumeric text, plus a column of status icons that might appear along its right edge (as you face it):

- The top line identifies and displays that program's operating state. The second and third lines display sets of status information, which you can cycle through by pressing the UP and Down keys to the right of the LCD.
- The bottom line indicates the functions (if any) of the top three keys (F1, F2 and F3).
- Various status icons (see Table 5-1 on page 62) are displayed along the right edge of the readout (as you face it).
- *The display panel backlight will automatically turn off if no keyboard activity has been detected in the last two minutes. Pressing any key will then turn it back on.*

3.1: Menu System

The control system is set up and administered via a hierarchical menu (see page 86) accessed by pressing the F3 key when the prompt above it reads “MENU”. If the administration password (see page 27) has its default value (0), the first Main Menu option will then be displayed:



If that password has a non-zero value, the Password entry screen will appear instead. Like many other menu screens, it assigns the HOME, BACK and SEL[ect] functions to the F1, F2 and F3 keys:

- Pressing HOME [F1] generally displays the parent menu for the current screen. If you are editing settings, any changes you have made to the current parameter will not be saved.
- Pressing BACK [F2] or the **Back** (bottom row, center) key generally restores the previously-displayed screen or, if you are editing numerical parameter values, backspaces over the most-recently typed digit.
- Pressing SEL [F3] or the **Enter** (bottom row, right) key generally displays the next parameter or screen in a sequence. If you are editing settings, any changes you have made to the current parameter will be saved.

In this case, pressing HOME [F1] would restore the operating state display (as would BACK [F2] or the Back key before you start typing the password):



To access the Main Menu, use the numeric keys to type the correct password, then press SEL [F3] or the Enter key. If the password was 56, for example:



Typing the first digit changes the F1 prompt to UNDO—pressing that key would then clear any digits you had typed so far and restore the initial Password screen. In contrast, pressing BACK [F2] or the Back key will clear only the last typed digit.

Whenever any Main Menu screen is displayed, you can scroll through its four options by pressing the Up or Down key, display the first option of the indicated subordinate menu by pressing SEL [F3] or the Enter key, or exit the menu system by pressing HOME [F1]:

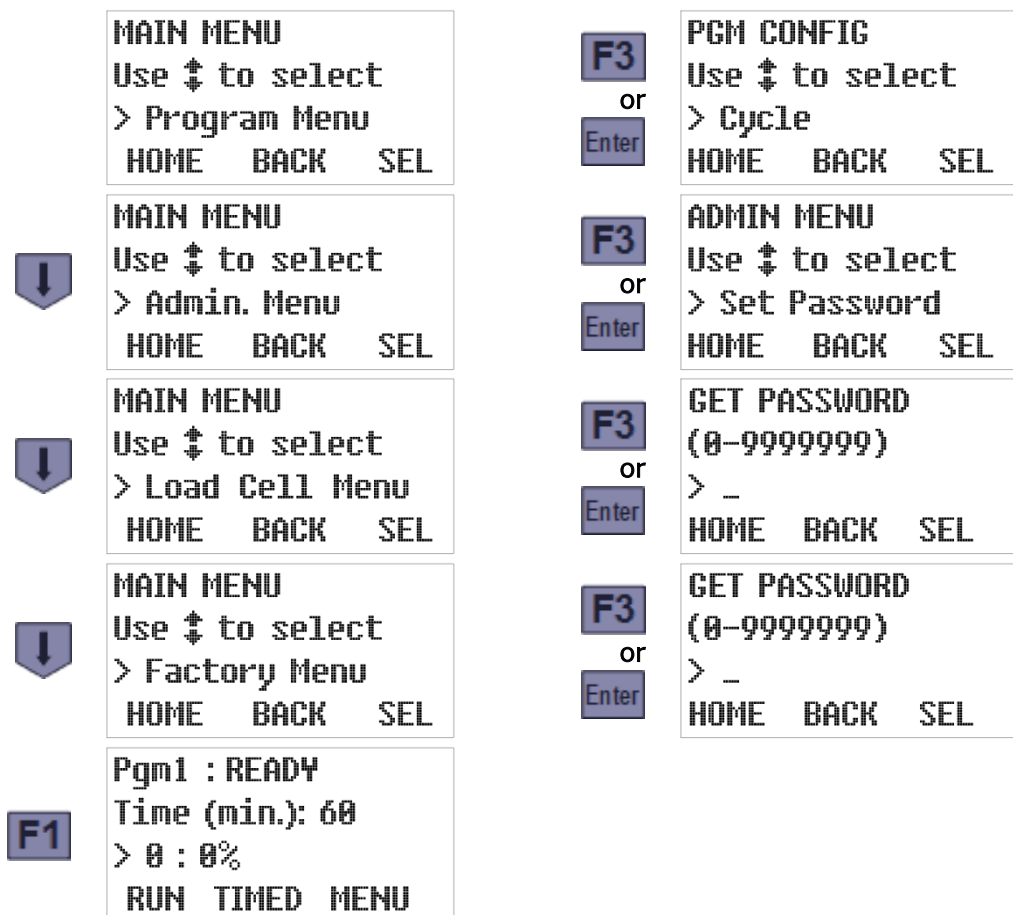

For convenience, each of those subordinate menus is set up so saving a setting (or initiating an action) automatically displays the next one. Also, pressing the Enter (or F3, if labeled SEL) key when a setting's current value is first displayed leaves it unchanged. So you can advance through the entire menu, viewing but not changing any settings, by simply pressing the Enter key enough times.

- ⚠ Access to the Load Cell and Factory Menus, which are used to adapt each controller to its sampler prior to shipment, are restricted by additional secret passwords.
- ⚠ The Load Cell Menu does not apply to units equipped with the CVE-16 sampling system.

3.2: Administration Menu

Administration Menu screens can be used to:

- change or clear the administration password (see page 27),
- set the real-time clock and enable/disable daylight savings time (see page 29),
- adjust the LCD brightness (page 30),
- download and erase the archived data (see page 31),
- change the unit's ID number (page 32), and/or
- select English or Metric volumetric units (page 32).

To access those features:

1. Access the **Main Menu** by pressing the MENU [F3] key and (if so prompted) entering the optional password (see Menu System above).
2. Press the DOWN key to scroll to the **Administration Menu** option, then press the SEL [F3] or Enter key to display that menu's first option:

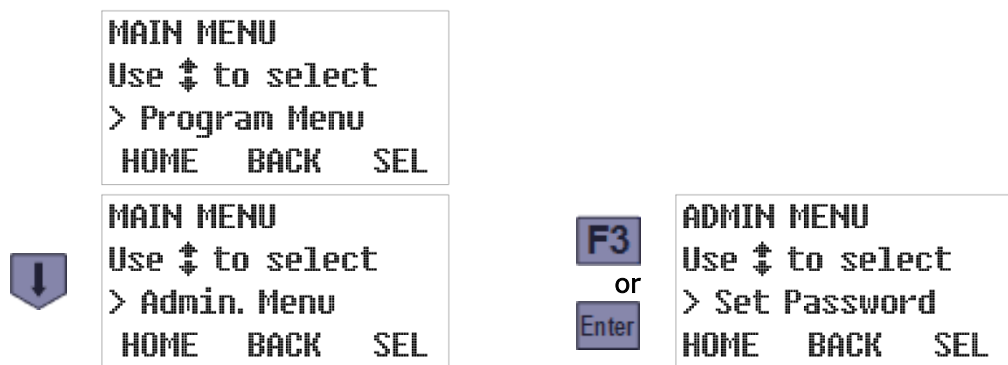

3.2.1: Administration Password

The **administration password** can be used to prevent unauthorized individuals from accessing the Administration and Program menus (see page 25):

- If it is set to zero (its factory default value), pressing the MENU [F3] key will immediately display the first Main Menu option.
- If it is assigned a value from 1 to 9,999,999 (leading zeroes are not allowed), pressing MENU [F3] will display the Password entry screen.

- ⚠ *The Load Cell and Factory Menus, which are meant to be used only by QCEC personnel, are protected by additional passwords that must be entered even if the administration password is cleared (set to zero).*
- ⚠ *If you forget the value of your administration password, contact QCEC for instructions on how to regain access to your sampler's menu system.*

To change the administration password's value:

1. Select the Administration menu (see page 27) to display its first option (Set Password). The second line of the readout will then show the range of allowable values while the third displays the current password:

```
ADMIN MENU
Use ↑ to select
> Set Password
HOME  BACK  SEL
```

F3

or

Enter

```
SET PASSWORD
(0-99999999)
> 8675309_
HOME  BACK  SEL
```

2. Type the new password by pressing the corresponding numeric keys (the old password will be erased and the F1 prompt will change from HOME to UNDO). Then press the SEL [F3] or Enter key to save the displayed password and advance to the next Administration Menu option. To change it to 56, for example, just press 5, then 6, and finally SEL [F3] or Enter. The new value will then be saved and the next Admin Menu option will be displayed:

5 **6**

```
SET PASSWORD
(0-99999999)
> 56_
UNDO  BACK  SEL
```

F3

or

Enter

```
ADMIN MENU
Use ↑ to select
> Clr Password
HOME  BACK  SEL
```

While entering a new password:

- Pressing UNDO [F1] would restore the old password value.
- Pressing BACK [F2] or the Back key would delete the right-most typed digit. Backspacing over the first digit will restore the old password.

Setting the password to zero (0) removes any previously set Administration and Program Menu protection. An easier way to do that, however, is to execute the second Admin Menu option:

1. Select the Administration Menu (see page 27 and press the DOWN key to display its Clear Password option.
2. Press the SEL [F3] or Enter key to immediately set the password to zero. A STATUS UPDATE screen will appear briefly, followed by the next Administration Menu option:

```
ADMIN MENU
Use ↑ to select
> Clr Password
HOME  BACK  SEL
```

F3

or

Enter

```
STATUS UPDATE
User Password
CLEARED
ESC
```

2 second
delay, then

```
ADMIN MENU
Use ↑ to select
> Set DST
HOME  BACK  SEL
```

3.2.2: Clock Settings

The control board includes a real-time clock chip with a backup battery, so it runs even when the control board is powered down. This enables it to timestamp all archived data and to collect samples at scheduled times. In addition, the current time and date are displayed on the third line of the second operating status screen (see page 67).

The third Administration Menu option allows you to quickly adjust the clock by one hour when daylight savings time (DST) begins or ends, while the fourth allows you to directly reset the clock to the current date and time. Because you should make sure the DST option is correct before setting the time, those options should be executed in the order presented:

1. Select the Administration Menu (see page 27), use the Down key to scroll to its third (Set DST) option, and then press the SEL [F3] or Enter key. The third line of the readout will then show the current daylight savings time setting:

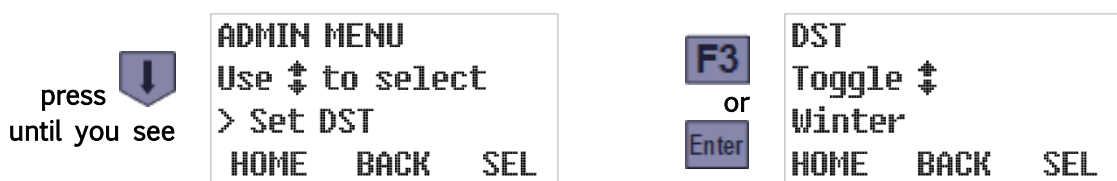

2. If necessary, press either the Up or the Down key to toggle that setting. When the desired setting is displayed, press the SEL [F3] or Enter key to save it and display the Set Clock option:



3. To adjust the date and time settings, press the SEL [F3] or Enter key. Otherwise, scroll to another Administration Menu option or press the HOME [F1] key to restore the Main Menu. The current date setting is displayed first. If it is correct, or after you have corrected it, press the Enter key to save the displayed date and access the current time setting:



The same techniques are used to change both settings. The third line displays the current value, with an underline cursor indicating the digit currently subject to editing:

- Press the Previous [F2] or Next [F3] key to move that cursor one digit left or right.
- Press any appropriate numeric key to set the current digit and advance the cursor, OR press the Up or Down key to increment or decrement the current digit.
- Press the ESC [F1] key to undo any change to the displayed setting and return to the Administration Menu/Set Clock screen.

- Pressing the Enter key while the time setting is displayed saves that time and displays the next Administration Menu option:

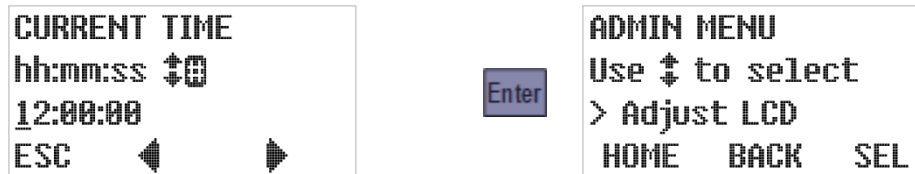

3.2.3: LCD Brightness

To adjust the brightness of the LCD backlight, which determines the contrast of the user interface panel:

- Select the Administration Menu (see page 27), use the Up or Down key to scroll to its fifth (Adjust LCD) option, and then press the SEL [F3] or Enter key to display the current setting:

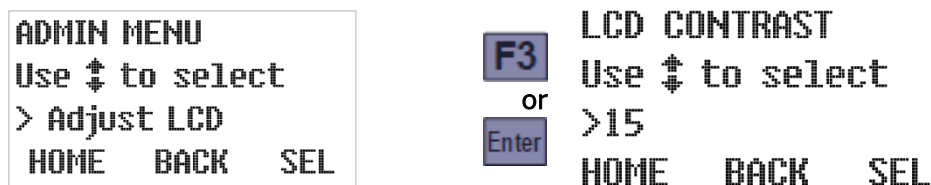

- Pressing the Up or Down key will increment or decrement that setting while making the screen slightly brighter or darker. The darkest possible setting is 0, the brightest is 30:



- Pressing the SEL [F3] or Enter key saves the displayed setting and displays the next Administration Menu option.



3.2.4: Archival Data Administration

Samplers manufactured since mid-March of 2016 archive timestamped sample collection records that their operators can review via the user interface panel (see pages 74 and 101).

To erase those log files from the microprocessor's memory, select the Administration Menu (see page 27), use the Up or Down key to scroll to its seventh (Clear Archive) option, and press the SEL [F3] or Enter key:

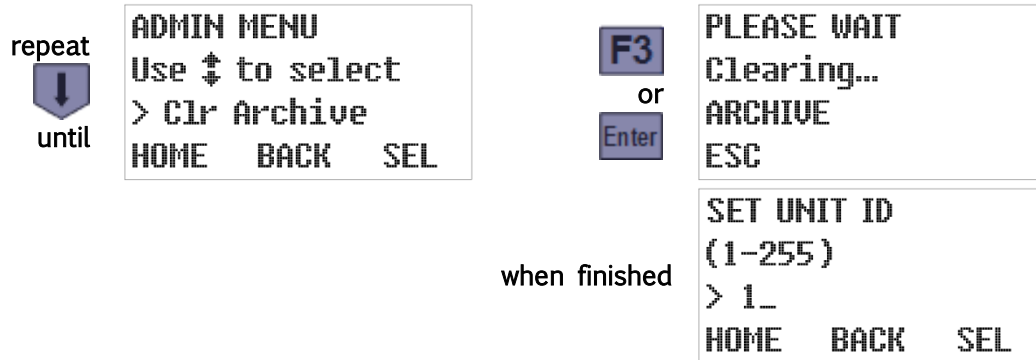

In future versions of the controller software, the Administration Menu's as-yet-unimplemented Download Archive option will allow users to copy that data to USB-connected memory devices or connected computers.

3.2.5: Set ID Number

Each sampler can be assigned a unique ID number that will be included in its archival data files and used to identify it via its serial communication channels. To set it:

1. Select the Administration Menu (see page 27), use the Down key to scroll to its Set ID option, and then press the SEL [F3] or Enter key to display the current ID:

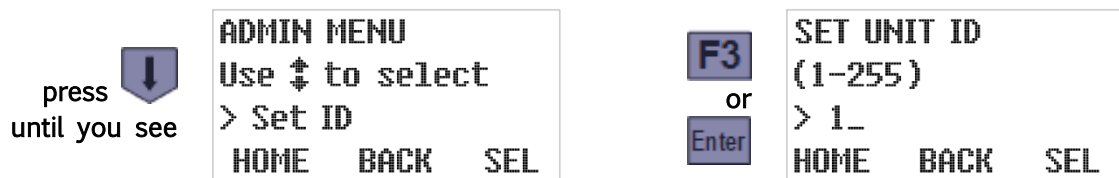

2. Type the new ID by pressing the corresponding numeric keys, then press the SEL [F3] or Enter key to save it and advance to the next Administration Menu option:



3.2.6: Set Volumetric Units

Each sampler can be configured on-the-fly to display flow volumes and composite bottle sizes in either English or metric units (e.g., gallons or liters). To do so:

3. Select the Administration Menu (see page 27), use the Up key to scroll to its Set Units option, and then press the SEL [F3] or Enter key to display the currently selected option:



4. Press the Up or Down key to toggle to this option's alternate value. Then press the SEL [F3] or Enter key to save the displayed setting and advance to the next Administration Menu option:



Chapter 4: Sampling Program Configuration

The user interface panel's **Program Menu** is used to configure the Sampling Programs (see Appendix A:) and specify which one is selected to be configured and/or started. Although you can directly view and change individual parameters in each program's set, the menu is designed so that all parameters for each program can be set in one continuous process:

- Each program's parameters are divided into several configuration groups.
- Selecting a specific program displays the first parameter in its first group.
- Pressing the SEL [F3] or Enter key (whether or not you have changed the displayed value) displays the next parameter in the same group.
- Options that are rendered inapplicable by those you have already set are not displayed.
- Setting the last parameter in any group returns you to the Program Configuration menu with the next parameter group selected.

In other words, simply access the Program Menu, select the program you want to configure, and then keep pressing the SEL [F3] or Enter key as you verify or change each setting.

4.1: Program Selection

Access the **Main Menu** by pressing the MENU [F3] key and (if so prompted) entering the optional password (see Menu System on page 25). The **Program Menu** should be the first Main Menu option—if not, use the Up or Down key to scroll to that option. Then press the SEL [F3] or Enter key to display the Program Select screen:

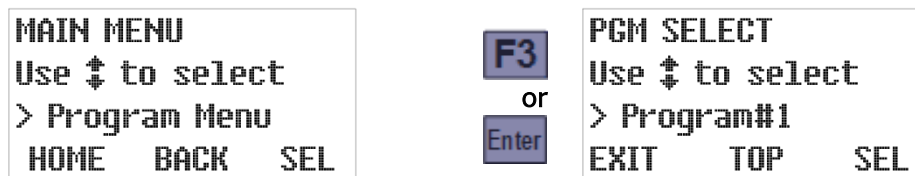

Use the Up or Down key to scroll to the program you want, then press the SEL [F3] or Enter key to select it and display the Program Configuration menu.



If that program has already been configured and you are just selecting it to be run, press HOME [F1] twice (or BACK [F2] or the Back key three times) to return to the Ready screen:



Otherwise, you can configure the selected program by setting the parameters in each of its five configuration groups (see next section).

4.2: Program Configuration Groups

The configuration parameters for each program are divided into five groups:

- Sampling Cycle Settings (see page 35)
- Sampling Intervals (see page 39)
- Bottle Options (see page 48)
- Run Options (see page 53)
- Program Events (see page 57)

To access a particular group, select the program you want to configure (see above) to display its Program Configuration menu. Use the Up or Down key to scroll to the parameter group of interest, then press the SEL [F3] or Enter key to display that group's first setting:

| | | | |
|---|---|-------------------------------|---|
| | <pre>PGM CONFIG Use ↑↓ to select >Cycle HOME BACK SEL</pre> | <pre>F3 or Enter</pre> | <pre>PREPURGE (0-99 sec.) > 15_ HOME BACK SEL</pre> |
| ↓ | <pre>PGM CONFIG Use ↑↓ to select >Smpl. Interval HOME BACK SEL</pre> | <pre>F3 or Enter</pre> | <pre>SMPL. INTERVAL Use ↑↓ to select >Time HOME BACK SEL</pre> |
| ↓ | <pre>PGM CONFIG Use ↑↓ to select >Bottle Opts. HOME BACK SEL</pre> | <pre>F3 or Enter</pre> | <pre>SAMPLE TYPE Use ↑↓ to select >Composite HOME BACK SEL</pre> |
| ↓ | <pre>PGM CONFIG Use ↑↓ to select >Pgm. Run Opts. HOME BACK SEL</pre> | <pre>F3 or Enter</pre> | <pre>AUTO RERUN Toggle ↑↓ >Enable HOME BACK SEL</pre> |
| ↓ | <pre>PGM CONFIG Use ↑↓ to select >Pgm. Events HOME BACK SEL</pre> | <pre>F3 or Enter</pre> | <pre>PGM EVENT #1 Use ↑↓ to select >End List HOME BACK SEL</pre> |

You can return to the Program Configuration menu from any parameter screen by pressing the HOME [F1] key, and then to the Program Selection screen by pressing the BACK [F2] key:

| | | | |
|-----------|--|-----------|--|
| F1 | <pre>PGM CONFIG Use ↑↓ to select >Cycle HOME BACK SEL</pre> | F2 | <pre>PGM SELECT Use ↑↓ to select > Program#1 EXIT TOP SEL</pre> |
|-----------|--|-----------|--|

4.3: Sampling Cycle Settings

This group includes the parameters that configure the sampling cycle (see page 69):

- pre-sampling purge duration (see page 35)
- sampling time (see page 36)
- post-sampling purge duration (see page 36)
- line conditioning rinses (see page 37)
- incomplete sample recycling (see page 38)
- consecutive sampling (see page 38)

To access those parameters, select the program you want to configure (see page 33) and press the SEL [F3] or Enter key to display its first parameter group (Cycle). Then press the SEL [F3] or Enter key again to display that group's first setting:

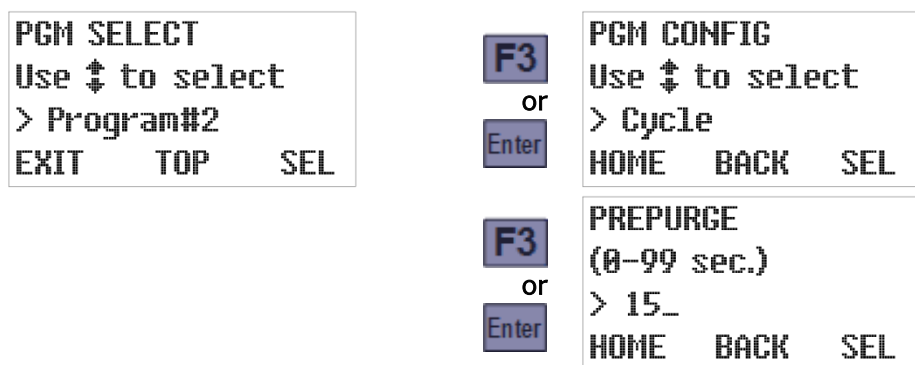

4.3.1: Pre-Sampling Purge Duration

This parameter specifies the number of seconds the chamber will be pressurized to clear the sampling tube prior to drawing a sample. To determine and optionally change its value:

1. Select the Cycle parameter group to display this parameter's current value (see above).
2. If desired, type a new prepurge duration by pressing the corresponding numeric keys. When you type the first digit, the old value is erased and the F1 prompt changes from HOME to UNDO. You can then press the UNDO [F1] key to start over, or the BACK [F2] or Back key to delete the most-recently typed digit.
3. Press the SEL [F3] or Enter key to save the displayed value (changed or not) and advance to the next Sampling Cycle group parameter.

To change the prepurge duration to 20 seconds, for example:



4.3.2: Sampling Time

This parameter specifies the maximum number of seconds the chamber will be depressurized to draw in each wastewater sample (if the liquid sensor is not triggered first). To determine and optionally change its value:

1. Accept or change the Prepurge duration, which will display this parameter's current value.
2. If desired, type a new sampling time by pressing the corresponding numeric keys. When you type the first digit, the old value is erased and the F1 prompt changes from HOME to UNDO. You can then press the UNDO [F1] key to start over, or the BACK [F2] or Back key to delete the most-recently typed digit.
3. Press the SEL [F3] or Enter key to save the displayed value (changed or not) and advance to the next Sampling Cycle group parameter.

To change the sample size to 45 seconds, for example:



- ⚠ *The sampling time must exceed the number of seconds needed to raise the water level in the chamber up to the liquid-sensing electrodes.*

4.3.3: Post-Sampling Purge Duration

This parameter specifies the number of seconds the chamber will be pressurized after each sample in order to force excess water from the chamber and clear the intake tube prior to discharging the samples. To determine and optionally change its value:

1. Accept or change the Sample Size, which will display this parameter's current value.
2. If desired, type a new postpurge duration by pressing the corresponding numeric keys. When you type the first digit, the old value will be erased and the F1 prompt will change from HOME to UNDO. You can then press the UNDO [F1] key to start over, or the BACK [F2] or Back key to delete the most-recently typed digit.
3. Press the SEL [F3] or Enter key to save the displayed value (changed or not) and advance to the next Sampling Cycle group parameter.

To change the postpurge time to 18 seconds, for example:



- ⚠ *The subsequent discharge phase will continue to pressurize the chamber for another 12 seconds. To avoid spraying the sample out under high pressure, the postpurge must clear all water from the intake line.*

4.3.4: Line Conditioning Rinses

This feature can be configured to rinse out the intake line up to four times prior to drawing each sample. To enable it, specify a non-zero number of rinses and then set its pressure and vacuum phase durations:

1. View/change the Postpurge Duration and then press the SEL [F3] or Enter key to display the currently-specified number of rinses (see above).
2. Type the desired value by pressing the corresponding numeric key. Then press the SEL [F3] or Enter key to save the displayed number of rinses:
 - Setting it to 0 disables this feature, in which case the screens for setting its pressure and vacuum phase durations will not be displayed:



- Setting it to any other value would display the current pressure phase duration:

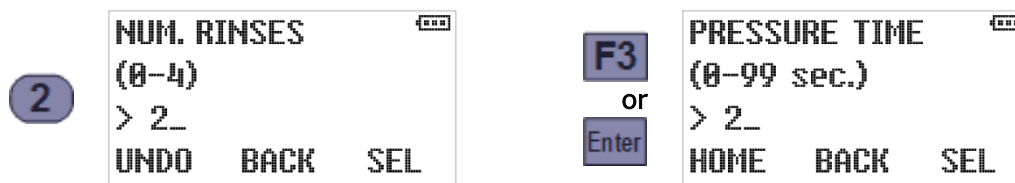

3. Type the new pressure time by pressing the corresponding numeric keys. Then press the SEL [F3] or Enter key to save the displayed pressure time and display the current vacuum phase duration:

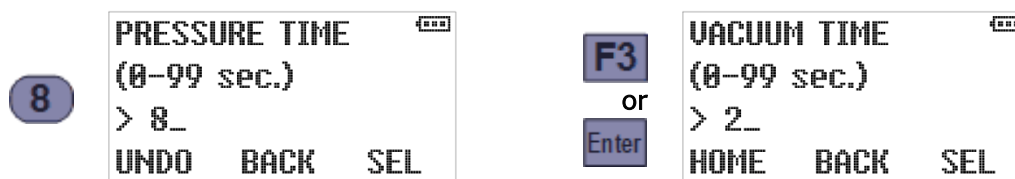

4. Type the new vacuum time by pressing the corresponding numeric keys. Then press the SEL [F3] or Enter key to save the displayed vacuum time and advance to the next Sampling Cycle group parameter:



⚠ The vacuum phase(s) should be brief enough to avoid drawing water into the sample chamber.

4.3.5: Incomplete Sample Recycling

If this feature is enabled, the controller will “recycle” the rinse, prepurge and vacuum stages of the sampling cycle as many as four times if the first cycle fails to fill the sample chamber. To enable or disable it:

1. View/change the rinse settings and then press the SEL [F3] or Enter key to display the current status of this feature.
2. You can enable this feature by pressing the 1 key, disable it by pressing the 0 key, or toggle its status by pressing the TGL [F2], Up or Down key.
3. Press the SEL [F3] or Enter key to save the displayed status and advance to the next Sampling Cycle group parameter.



4.3.6: Consecutive Sampling

This parameter specifies the number of samples to be drawn at the end of each time or flow interval. If you set it to more than one, the full sampling cycle will be repeated the specified number of times for each interval.

You might want to specify more than one and configure appropriate bottle options (see page 48) for either of two reasons:

- Drawing several samples one after the other and discharging them to the same container effectively allows you to collect samples larger than the 900 ml maximum size.
- Drawing consecutive samples and discharging them to different containers allows you to save and process duplicate samples for verification purposes.

To view/change the number of samples to be drawn per interval:

1. View/change the previous (postpurge or rinse) setting and then press the SEL [F3] or Enter key to display the current value of this parameter.
2. Type the new value by pressing the corresponding numeric keys. Then press the SEL [F3] or Enter key to save the displayed value and return to the Program Configuration menu scrolled to the next parameter group:

To configure a sample to draw two samples per interval, for example:



4.4: Sampling Intervals

This group includes one main parameter that specifies the type of sampling interval(s) the controller will use, and several parameter groups that configure those interval(s).

To directly access the sampling interval type, select the program you want to configure (see page 33), then press the Down key to scroll to the Sample Intervals group:

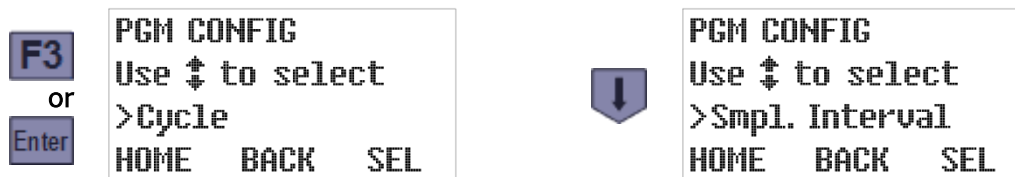

Press the SEL [F3] or Enter key to display the currently-configured interval type, then use the Down or Up key to scroll to the desired new setting. With that value displayed, press the SEL [F3] or Enter key to display the first parameter for that interval type:

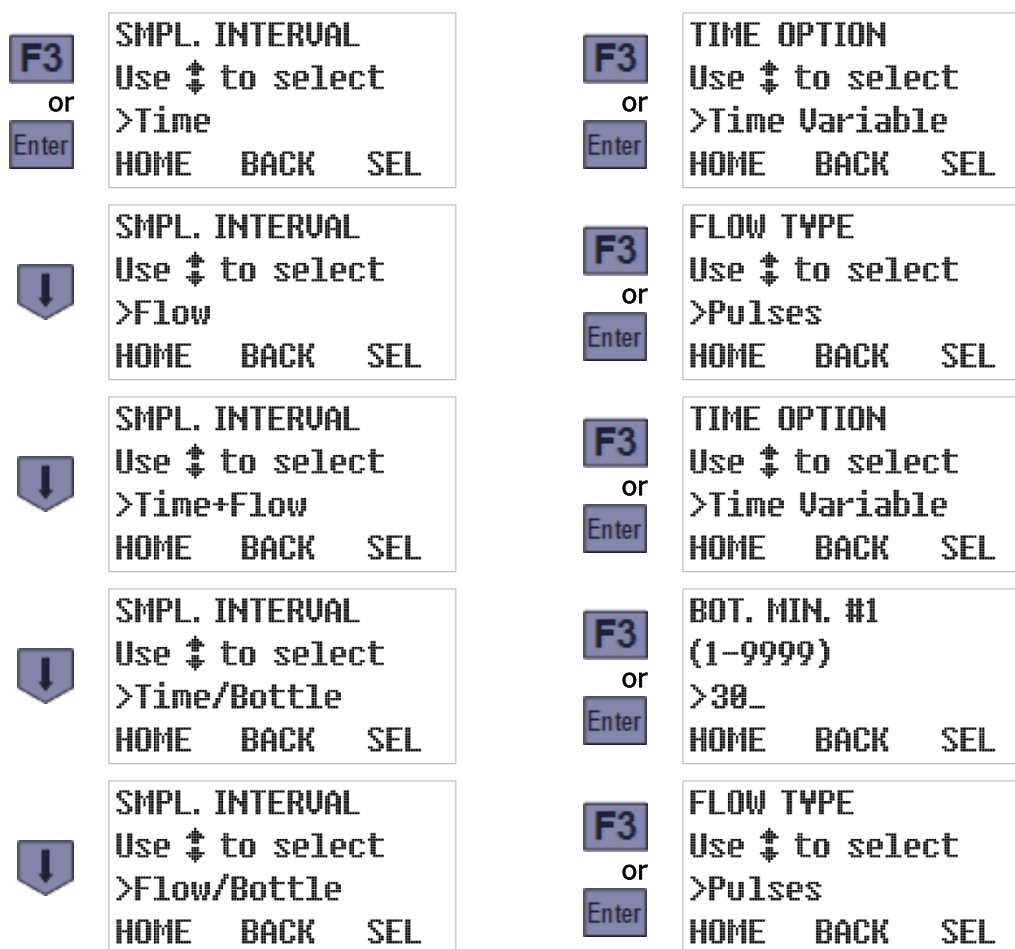

The “per bottle” options will appear only if your controller is equipped with the multiple-bottle turntable and factory-configured to display the discrete-sampling bottle options.

4.4.1: Timed Interval Sampling

Selecting the **Time** sampling interval option configures the controller to wait a specified number of minutes after initiating one sample before initiating the next:

- If the samples are to be drawn at regular intervals, select the **Time Fixed** option and then set the fixed length of those intervals. For example, you might configure a program to draw samples every 60 minutes until it is stopped.
- Otherwise, select the **Time Variable** option and then specify no more than 24 time intervals. One sample will be drawn at the end of each specified interval, after which the last interval will be repeated until the program is stopped. For example, you might configure a program to draw its first sample an hour after starting and then switch to 30 minute intervals.

To select the desired option:

1. Scroll the Sample Interval parameter's value to Time (see above), then press the SEL [F3] or Enter key to save that value and display the currently-selected Time Option:

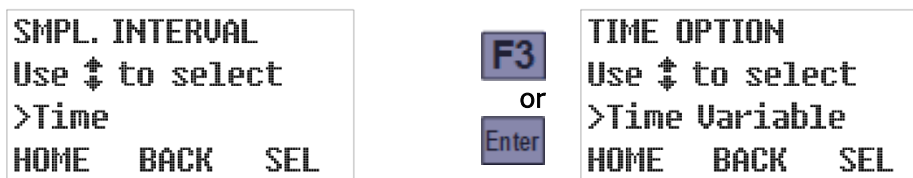

2. Use the Up or Down key to toggle between that parameter's two possible values, then press the SEL [F3] or Enter key to save the displayed value and display its first setting:

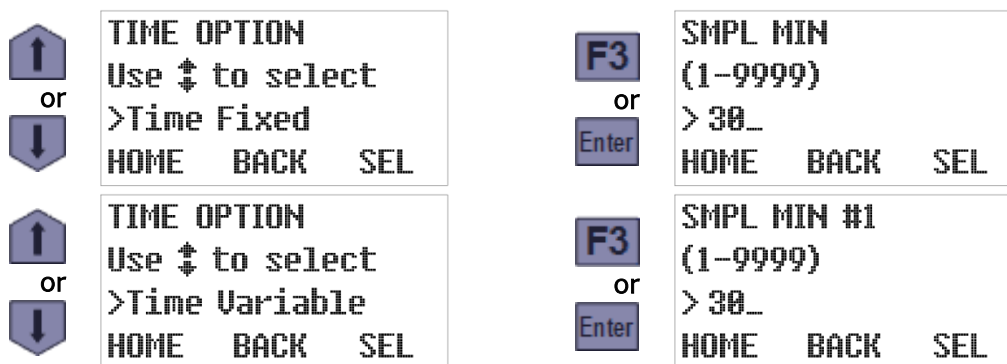

4.4.1.1: Fixed Length Time Intervals

As shown above, selecting the **Time Fixed** option displays its first (and only) parameter—the length of time it waits between initiating any sample and the next. To change it, type the new duration (20 minutes, for example) by pressing the corresponding numeric keys. Then press the SEL [F3] or Enter key to save the displayed Sample Minutes (changed or not) and display the Program Configuration menu's Bottle Options screen:



4.4.1.2: Variable Length Time Intervals

As shown previously, selecting the **Time Variable** option displays the first of 24 Sample Minutes parameters—the length of time it will wait before drawing its first sample. To change its value, type the new duration (20 minutes, for example) by pressing the corresponding numeric keys. Press the SEL [F3] or Enter key to save that value (changed or not) and display the next:



The digit keys can then be used to change the number of minutes the program would wait between initiating its first and second samples. Pressing the SEL [F3] or Enter key would again save the displayed value and display the next. And so on until pressing the SEL [F3] or Enter key while Sample Minutes #24 is displayed restores the Program Configuration menu scrolled to its next group (Bottle Options).



However, you do not need to set all 24 intervals—setting any one of them to 0 configures the program to use the value of the preceding parameter for all subsequent intervals. For example, setting Sample Minutes #5 to 120 and Sample Minutes #6 to 0 would have the same effect as setting Sample Minutes #6 through #24 all to 120 (the value of Sample Minutes #5):

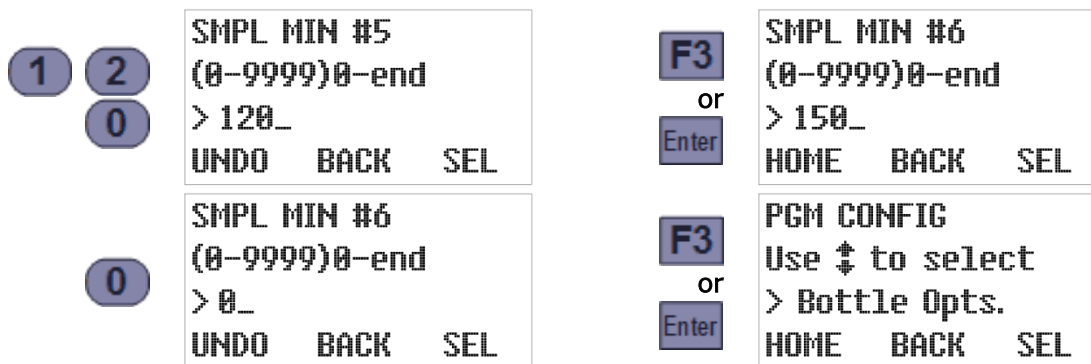

4.4.2: Flow Interval Sampling

Selecting the **Flow** sampling interval option configures the controller to initiate sampling as its accumulated flow measurement increases by specified volumes. You must then:

- Select the flow input type (4-20 mA, 0-5 Vdc, 0-10 Vdc, or discrete pulse).
- Specify the flow rate corresponding to the maximum signal (analog input only).
- Specify the incremental flow between the initiation of one sample and the next:
 - If the samples are to be drawn at regular intervals (for example, after each 5000 gallon flow increment), select the **Flow Fixed** option and set the fixed length of those intervals.
 - Otherwise, select the **Flow Variable** option and specify no more than 24 flow intervals. One sample will be drawn at the end of each specified interval, after which the last interval will be repeated until the program is stopped. For example, you might configure a program to draw its first sample when the total flow reaches 5000 gallons, and then switch to 2500 gallon intervals (i.e., after 7500, 10000 and so on total gallons).

Flow volumes are specified in either gallons or liters, depending on the current Administration Menu Set Units setting (see page 32).

To specify the input type, scroll the Sample Interval parameter's value to Flow, then press the SEL [F3] or Enter key to save that value and display the currently-selected Flow Type:



Use the Up or Down key to scroll to the desired type, then press the SEL [F3] or Enter key to save it and display its first setting:

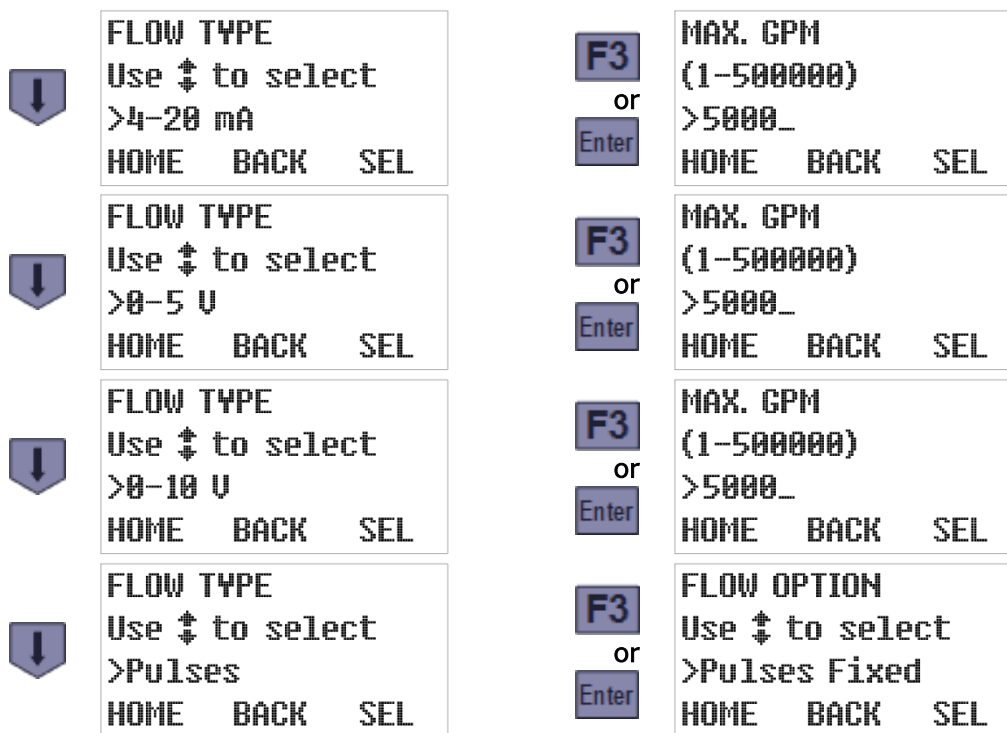

4.4.2.1: Analog Flow Input

If you select one of the analog inputs types (4-20 mA, 0-5 Vdc, or 0-10 Vdc), samples will be initiated an integer number of gallons apart. Thus, you must specify the flow rate (in gallons per minute) corresponding to the transmitter's maximum signal, after which you can specify the sampling intervals in gallons:

1. Select the flow input type (as described above) to display the current maximum flow rate setting (the rate at which the transmitter would transmit its maximum signal). This example shows the 0-10 Vdc option, but the resulting screen would be the same for the 0-5 Vdc or 4-20 mA options as well:

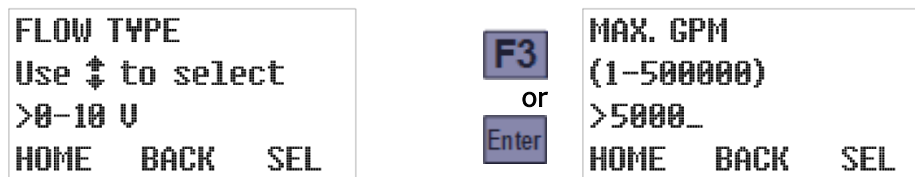

2. To change that setting, type a new maximum flow rate by pressing the corresponding numeric keys. When you type the first digit, the old value will be erased and the F1 prompt will change from HOME to UNDO. You can then press the UNDO [F1] key to start over, or the BACK [F2] or Back key to delete the most-recently typed digit.
3. Press the SEL [F3] or Enter key to save the displayed value (changed or not) and display the current flow option (fixed or variable sampling intervals). As an example:



The above example assumes you are using a flow transmitter whose signal varies from 0 Vdc at no flow up to 10 Vdc at 1500 gallons per minute. A 1.0 Vdc signal would then indicate the flow was 150 gpm, so the controller would then calculate the instantaneous flow by multiplying 150 by the input signal in volts.

4. Use the Up or Down key to toggle between the Flow Option's two possible values, then press the SEL [F3] or Enter key to save the displayed value and display its first setting:

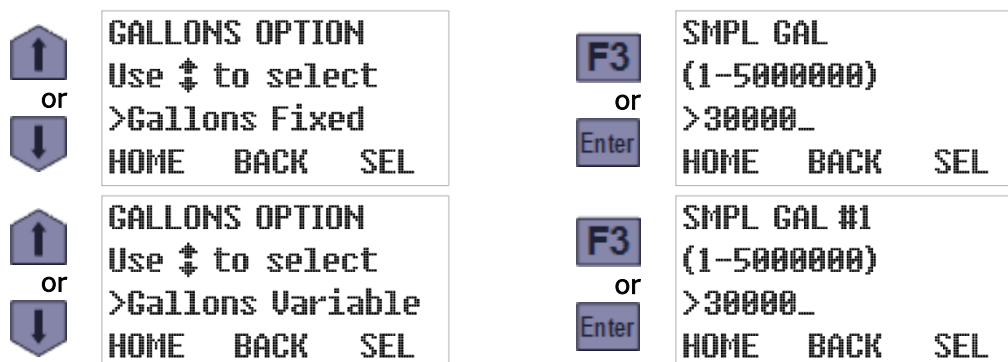

4.4.2.1.1: Fixed Volume Flow Intervals

As shown previously, selecting the **Flow Fixed** option displays its only parameter—the specified change in flow between samples. To change that interval, type a new value by pressing the corresponding numeric keys. Then press the SEL [F3] or Enter key to save the displayed Sample Gallons (changed or not) and display the Program Configuration menu's next screen:



4.4.2.1.2: Variable Volume Flow Intervals

As shown previously, selecting the **Flow Variable** option displays the first of 24 Sample Gallons parameters—the incremental flow at which the controller will draw its first sample. To change it, type the new flow increment (2400 gallons, for example) by pressing the corresponding numeric keys. Press the SEL [F3] or Enter key to save that value (changed or not) and display the next:



The digit keys can then be used to change the number of gallons the program would measure between initiating its first and second samples. Pressing the SEL [F3] or Enter key would again save the displayed value and display the next. And so on until pressing the SEL [F3] or Enter key while Sample Gallons #24 is displayed restores the Program Configuration menu scrolled to its next group (Bottle Options):



However, you do not need to set all 24 intervals—setting any one of them to 0 configures the program to use the value of the preceding parameter for all subsequent intervals. For example, setting Sample Gallons #5 to 4000 and Sample Gallons #6 to 0 would have the same effect as setting Sample Gallons #6 through #24 all to 4000 (the value of Sample Gallons #5):

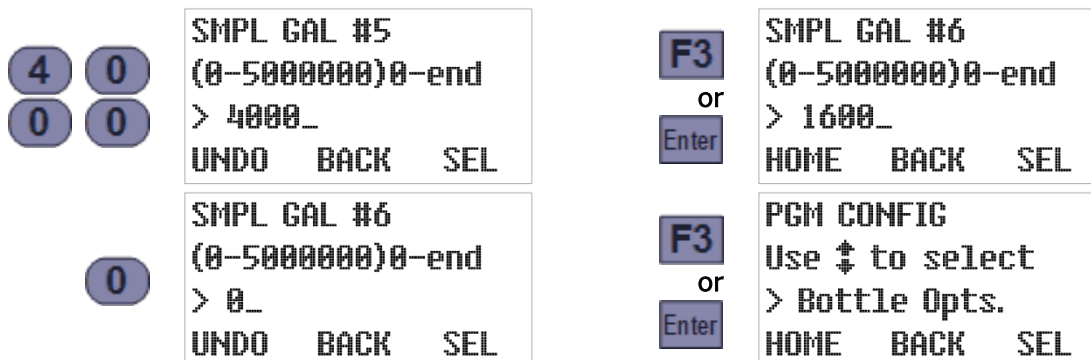

4.4.2.2: Pulsing Flow Input

The pulse flow type is for meters that transmit discrete pulses at specific flow intervals. For example, a meter that sends one pulse for every 100 gallons of flow will transmit its first pulse when the total flow it has measured reaches 100 gallons, a second at 200 gallons, and so on.

When this flow type is selected, you must configure the controller to draw samples at intervals that are an integer number of pulses apart (which correspond to the flow increments at which you really want it to draw samples):

1. Select the pulse flow type (see page 42) to display the current value of the flow option (fixed or variable intervals):

```
FLOW TYPE
Use ↑↓ to select
>Pulses
HOME  BACK  SEL
```

```
F3
or
Enter
FLOW OPTION
Use ↑↓ to select
>Pulses Variable
HOME  BACK  SEL
```

2. Use the Up or Down key to toggle between that parameter's two possible values, then press the SEL [F3] or Enter key to save the displayed value and display its first setting:

```
↑
or
↓
FLOW OPTION
Use ↑↓ to select
>Pulses Fixed
HOME  BACK  SEL
```

```
F3
or
Enter
SMPL PULSES
(1-9999)
>320_
HOME  BACK  SEL
```

```
↑
or
↓
FLOW OPTION
Use ↑↓ to select
>Pulses Variable
HOME  BACK  SEL
```

```
F3
or
Enter
SMPL PULSES #1
(1-9999)
>320_
HOME  BACK  SEL
```

4.4.2.2.1: Fixed Pulses Flow Intervals

As shown above, selecting the **Pulses Fixed** option displays its only parameter—the specified number of input pulses between samples. To change that setting, type the new interval pulse count (240, for example) by pressing the corresponding numeric keys. Then press the SEL [F3] or Enter key to save the displayed Sample Pulses (changed or not) and display the Program Configuration menu's next screen:

```
2 4
0
SMPL PULSES
(1-9999)
>320_
HOME  BACK  SEL
```

```
F3
or
Enter
PGM CONFIG
Use ↑↓ to select
> Bottle Opts.
HOME  BACK  SEL
```

You can repurpose the flow-pulse input to initiate a sample each time a connected PLC or other external device closes its circuit (see page 89). In that case, you would of course set this parameter to 1.

4.4.2.2: Variable Pulses Flow Intervals

Selecting the **Pulses Variable** option displays the first of 24 Sample Pulses parameters—the number of pulses at which the controller will draw its first sample. To change it, type the new first sample pulse count (240, for example) by pressing the corresponding numeric keys. Press the SEL [F3] or Enter key to save that value (changed or not) and display the next:



The digit keys can then be used to change the number of pulses the program would wait between initiating its first and second samples. Pressing the SEL [F3] or Enter key would again save the displayed value and display the next. And so on until pressing the SEL [F3] or Enter key while Sample Pulses #24 is displayed restores the Program Configuration menu scrolled to its next group (Bottle Options):

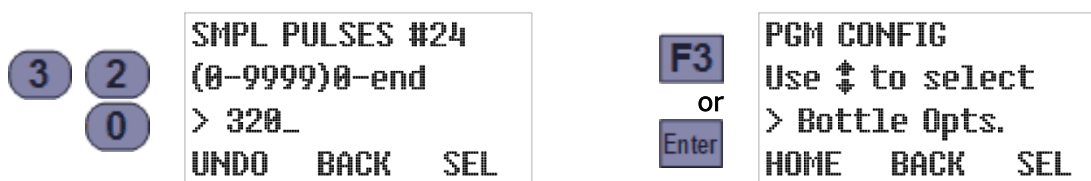

However, you do not need to set all 24 intervals—setting any one of them to 0 configures the program to use the value of the preceding parameter for all subsequent intervals. For example, setting Sample Pulses #5 to 400 and Sample Pulses #6 to 0 would have the same effect as setting Sample Pulses #6 through #24 all to 400 (the value of Sample Pulses #5):

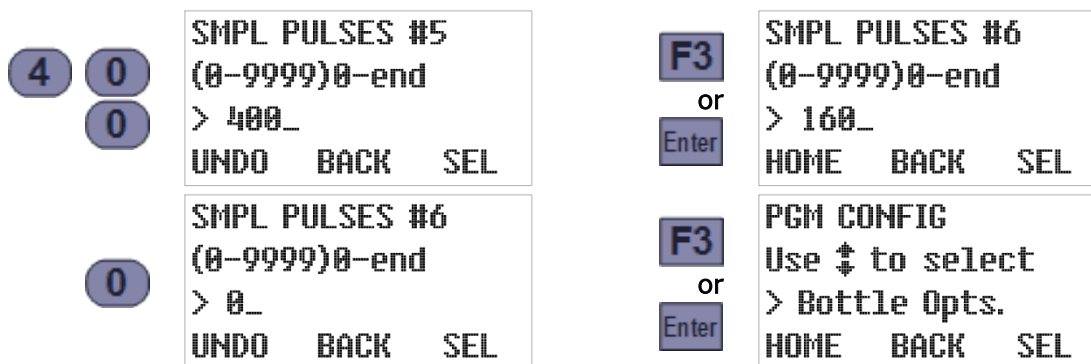

4.4.3: Time+Flow Interval Sampling

Selecting the **Time+Flow** sampling interval option configures the controller to draw samples at either time or flow intervals, whichever proves to be the soonest for each sample. In other words, it accumulates both the time and the flow since the last sample was initiated, and initiates the next (and resets both counters) as soon as either reaches its configured target.

When this option is selected, you will be prompted to:

1. select the Time Option and set its associated parameters (see page 40), and then
2. select the Flow Type and Option and set their associated parameters (see page 42).

4.4.4: Per-Bottle Timed Interval Sampling

Selecting a sequential sampler's **Time/Bottle** interval option configures it to draw samples at time intervals that are tied to the rotation of the bottle carousel.

To configure this option, scroll the Sample Interval parameter to Time/Bottle (see page 39), then press the SEL [F3] or Enter key to save that choice and display the first of its 24 Bottle Minutes parameters—the length of time it will wait between samples when bottle 1 is positioned beneath the sampling chamber:

| | | |
|---|---------------------------------|--|
| <pre>SMPL. INTERVAL Use ↓ to select >Time/Bottle HOME BACK SEL</pre> | F3 or Enter | <pre>BOT. MIN. #1 (1-9999) >30_ HOME BACK SEL</pre> |
|---|---------------------------------|--|

To change that interval, type the new duration by pressing the corresponding numeric keys. Press the SEL [F3] or Enter key to save that value (changed or not) and display the next:

| | | | |
|-------------------|--|---------------------------------|---|
| 2 0 | <pre>BOT. MIN. #1 (1-9999) >20_ UNDO BACK SEL</pre> | F3 or Enter | <pre>BOT. MIN. #2 (0-9999)0-end >60_ HOME BACK SEL</pre> |
|-------------------|--|---------------------------------|---|

The digit keys can then be used to change the number of minutes the program would wait between samples for the second bottle. Pressing the SEL [F3] or Enter key would again save the displayed value and display the next. And so on until pressing the SEL [F3] or Enter key while Bottle Minutes #24 is displayed restores the Program Configuration menu scrolled to its next group (Bottle Options).

| | | | |
|-------------------|--|---------------------------------|---|
| 6 0 | <pre>BOT. MIN. #24 (0-9999)0-end >60_ UNDO BACK SEL</pre> | F3 or Enter | <pre>PGM CONFIG Use ↓ to select > Bottle Opts. HOME BACK SEL</pre> |
|-------------------|--|---------------------------------|---|

However, you do not need to set all 24 intervals—setting any one of them to 0 configures the program to use the value of the preceding parameter for all subsequent intervals. For example, setting Bottle Minutes #5 to 120 and Bottle Minutes #6 to 0 would have the same effect as setting Bottle Minutes #6 through #24 all to 120 (the value of Bottle Minutes #5):

| | | | |
|-------------------------------|--|---------------------------------|---|
| 1 2 0 | <pre>BOT. MIN. #5 (0-9999)0-end >120_ UNDO BACK SEL</pre> | F3 or Enter | <pre>BOT. MIN. #6 (0-9999)0-end >150_ HOME BACK SEL</pre> |
| 0 | <pre>BOT. MIN. #6 (0-9999)0-end >0_ UNDO BACK SEL</pre> | F3 or Enter | <pre>PGM CONFIG Use ↓ to select > Bottle Opts. HOME BACK SEL</pre> |

4.4.5: Per-Bottle Flow Interval Sampling

Selecting the **Flow/Bottle** sampling interval option configures the program to draw samples at flow intervals that are tied to the position of the bottle carousel.

Before specifying those intervals, you must first select the flow input type. For instructions on doing that, please refer to the Flow Interval Sampling section on page 42. Once you have done that, the screens you will see depend on whether you are using an analog or a discrete input:

- For analog flow inputs, you first specify the flow rate corresponding to the transmitter's maximum signal and then specify the sampling intervals in gallons. The procedures are the same as described previously in the Analog Flow Input section on page 43 and the Variable Volume Flow Intervals section on page 44.

The flow interval for samples deposited to the first bottle are specified by the Sample Gallons #1 parameter, the interval for the second bottle's samples are specified by the Sample Gallons #2 parameter, and so on.

- For discrete flow signals, those intervals are specified as pulse counts. The procedure is the same as described previously in the Variable Pulses Flow Intervals section on page 46.

The flow interval for samples deposited to the first bottle are specified by the Sample Pulses #1 parameter, the interval for the second bottle's samples are specified by the Sample Pulses #2 parameter, and so on.

4.5: Bottle Options

This group includes one main parameter that specifies which type of sample containers your sampler has (see page 16), and a set of parameters for each possible type. To directly access that main parameter, select the program you want to configure (see page 33), then press the Down key twice to scroll to the Bottle Options group:





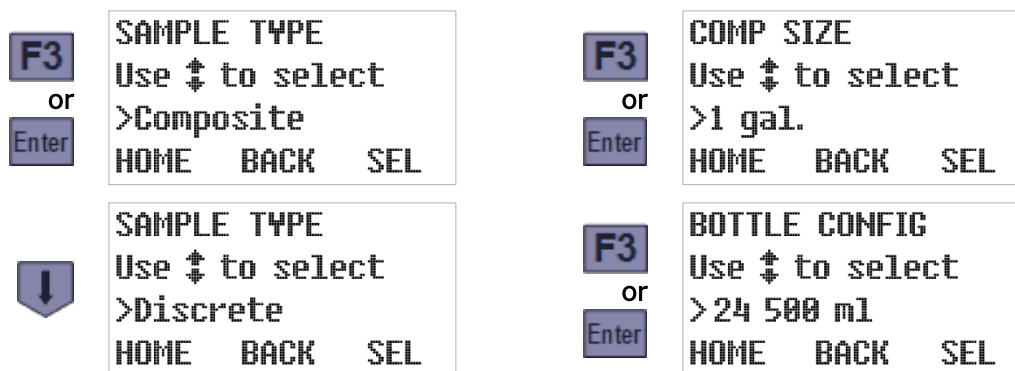



Press the SEL [F3] or Enter key to display the currently-selected storage type, then use the Down or Up key to toggle between that parameter's two possible values. Pressing the SEL [F3] or Enter key will display the first parameter for that sample storage option:

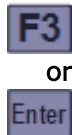
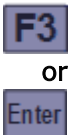

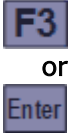
4.5.1: Composite Sample Containers

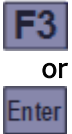
The **Composite** Sample Type configures the controller to discharge all samples into a single container, and (as shown above) displays the currently-configured container size. That size will be shown in either liters or gallons, depending on the current Administration Menu Set Units setting (see page 32). Use the Up or Down key to scroll to the container size you are using, then press the SEL [F3] or Enter key to save that setting and display the number of samples that container is currently set to receive:

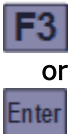
| | | | |
|---|---|---|---|
|  | COMP SIZE Use ↑↓ to select >1 gal. HOME BACK SEL |  | SMPLS/BOTTLE (1-170) >170_ HOME BACK SEL |
|  | COMP SIZE Use ↑↓ to select >2.5 gal. HOME BACK SEL |  | SMPLS/BOTTLE (1-425) >425_ HOME BACK SEL |
|  | COMP SIZE Use ↑↓ to select >3 gal. HOME BACK SEL |  | SMPLS/BOTTLE (1-511) >511_ HOME BACK SEL |
|  | COMP SIZE Use ↑↓ to select >5 gal. HOME BACK SEL |  | SMPLS/BOTTLE (1-851) >851_ HOME BACK SEL |

- ⚠ Each unit is generally factory set to display only the bottle sizes its owner purchased, so the options you see will probably differ from those shown above.

The digit keys can then be used to change the number of samples the program will discharge to the container before automatically stopping itself. Pressing the SEL [F3] or Enter key will save the displayed value and display the Program Configuration menu with its next group selected:

| | | | |
|---|--|---|---|
|  | SMPLS/BOTTLE (1-425) >48_ UNDO BACK SEL |  | PGM CONFIG Use ↑↓ to select > Pgm. Run Opts. HOME BACK SEL |
|---|--|---|---|

- ⚠ The indicated maximum samples per bottle is calculated by dividing 90 percent of the container volume by the 20 milliliter minimum sample size. The actual limit will obviously be proportionately lower when larger samples are being collected.
- ⚠ Composite samples are equipped with a liquid-level sensor that will stop the sampling process when the bottle is approximately 90 percent full, even if the number of samples collected is less than the value of this parameter.

4.5.1: Discrete/Sequential Sample Containers

Selecting the **Discrete** bottle option configures the controller to discharge samples into multiple bottles mounted in a rotating carousel, and (as previously shown) displays the currently-selected bottle configuration. Use the Up or Down key to scroll to the configuration you are using, then press the SEL [F3] or Enter key to save that setting and display how many of those bottles the program is currently configured to use:

- ⚠ Each sampler is factory-configured to display only the Bottle Configuration options it was shipped with, so the choices you see will probably differ from those shown below.

| | | | |
|---|---|-------------------|--|
| ↓ | BOTTLE CONFIG Use ↑↓ to select >24 500 ml HOME BACK SEL | F3 or Enter | NUM. BOTTLES (1-24) > 24_ HOME BACK SEL |
| ↓ | BOTTLE CONFIG Use ↑↓ to select >24 1000 ml HOME BACK SEL | F3 or Enter | NUM. BOTTLES (1-24) > 24_ HOME BACK SEL |
| ↓ | BOTTLE CONFIG Use ↑↓ to select >2 2.5 gal. HOME BACK SEL | F3 or Enter | NUM. BOTTLES (1-2) > 2_ HOME BACK SEL |
| ↓ | BOTTLE CONFIG Use ↑↓ to select >2 3 gal. HOME BACK SEL | F3 or Enter | NUM. BOTTLES (1-2) > 2_ HOME BACK SEL |

The numeric keys can then be used to change that number, and pressing the SEL [F3] or Enter key will save the displayed value (changed or not) and display the maximum number of samples the program is currently set to discharge to each bottle:

| | | | |
|-----|--|-------------------|---|
| 1 2 | NUM. BOTTLES (1-24) > 12_ UNDO BACK SEL | F3 or Enter | SMPLS/BOTTLE (1-45) >45_ HOME BACK SEL |
|-----|--|-------------------|---|

The numeric keys can then be used to change that number, and pressing the SEL [F3] or Enter key will again save the displayed value and display the currently bottle indexing setting:

| | | | |
|---|--|-------------------|--|
| 4 | SMPLS/BOTTLE (1-45) >4_ UNDO BACK SEL | F3 or Enter | INDEX TYPE Use ↑↓ to select >After Bottle HOME BACK SEL |
|---|--|-------------------|--|

4.5.1.1: Bottle Indexing Options

The controller can be configured to rotate the next bottle under the sampling chamber using any one of the following indexing criteria:

- The **After Bottle** option rotates the turntable after the specified number of samples have been discharged to the current bottle. For example, if each bottle is to get 3 samples, the carousel will be turned after the third sample, the sixth, the ninth, and so on until the previously specified number of bottles have each received 3 samples.
- The **After Sample** option rotates the turntable after each sample, and continues doing so until the specified number of samples have been discharged to each bottle. For example, if each bottle is to receive 3 samples, the carousel will make three full revolutions.
- The **After Time** option rotates the turntable each time a specified indexing interval elapses. For example, the carousel might be turned every 3 hours until the previously-specified number of bottles have been serviced. This option is usually combined with Flow Interval sampling to provide flow-proportional sampling.
- The **Real Time** option rotates the turntable at fixed-duration intervals starting at a specified time of day (today if the program is started before that time, otherwise tomorrow).

Use the Up or Down key to scroll to the indexing type you wish to use, then press the SEL [F3] or Enter key to save that choice and display its first associated parameter (if any) or return to the Program Configuration menu with its next group selected:

| | | | |
|---|--|-------------------|--|
| ↓ | <pre>INDEX TYPE Use ↓ to select >After Bottle HOME BACK SEL</pre> | F3 or Enter | <pre>PGM CONFIG Use ↓ to select >Pgm. Run Opts. HOME BACK SEL</pre> |
| ↓ | <pre>INDEX TYPE Use ↓ to select >After Sample HOME BACK SEL</pre> | F3 or Enter | <pre>PGM CONFIG Use ↓ to select >Pgm. Run Opts. HOME BACK SEL</pre> |
| ↓ | <pre>INDEX TYPE Use ↓ to select >After Time HOME BACK SEL</pre> | F3 or Enter | <pre>INDEX MIN. (1-9999) > 60_ HOME BACK SEL</pre> |
| ↓ | <pre>INDEX TYPE Use ↓ to select >Real Time HOME BACK SEL</pre> | F3 or Enter | <pre>INDEX TIME hh:mm:ss ⚙ 12:34:56 ESC ◀ ▶</pre> |

4.5.1.1.1: After Time Indexing

As shown above, selecting the **After Time** indexing type displays the number of minutes each bottle will be positioned under the sampling chamber. You can then use the numeric keys to change that setting, and pressing the SEL [F3] or Enter key will again save the displayed value (changed or not) and display the Program Configuration menu with its next group selected:



4.5.1.1.2: Real Time Indexing

As shown on the previous page, selecting **Real Time** indexing displays the time of day at which timed-indexing of the bottle carousel is to begin (see page 97):

- Press the Previous [F2] or Next [F3] key to move the underline cursor (which initially selects the first digit of the hour for editing) one digit left or right.
- Press the appropriate numeric key to set the selected digit and automatically move the cursor to the right, OR
Press the Up or Down key to increment or decrement that digit, then press the Previous [F2] or Next [F3] key to manually move the cursor.
- Press the ESC [F1] key to cancel any changes and redisplay the Index Type screen.

Pressing the Enter key will then save the displayed time and display the number of minutes each bottle will be positioned under the sampling chamber from that time forward:

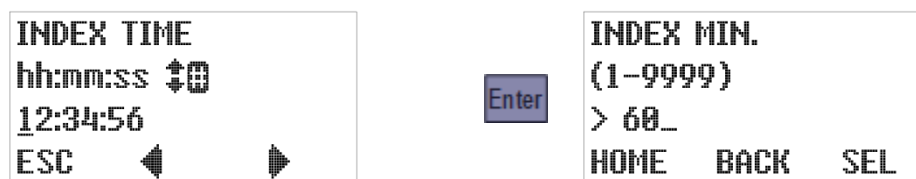

You can then use the numeric keys to change that indexing interval, and press the SEL [F3] or Enter key to save its displayed value (changed or not) and display the Program Configuration menu with its next group selected:



4.6: Program Run Options

This group includes the parameters that configure the following features:

- automatic rerun (see page 53)
- delayed starting (see page 54)
- float enable (see page 55)
- fault enable (see page 54)
- timed stop (see page 55)
- bottle limit override (see page 56)

To directly access those parameters, select the program you want to configure (see page 33):

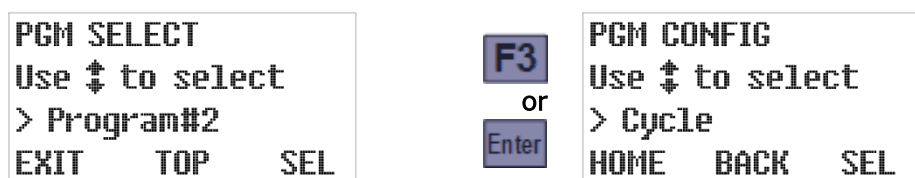

Press the Up key twice to scroll to the Program Configuration menu's Run Options group, then press the SEL [F3] or Enter key again to display that group's first setting:



4.6.1: Automatic Rerun

By default, the sampling program must be manually reset each time it stops, which indicates to the controller that the sample containers have been emptied. If you configure a Start Event (see page 57) to repeatedly start and stop the sampler, enabling the Automatic Rerun parameter as well would enable the program to restart without being reset.

⚠ You should not enable this parameter unless you are scheduling automatic start events.

To view and optionally change this setting:

1. Select the Run Options group to display this parameter's current value (see above).
2. If desired, press the Up or Down key to toggle it on or off, then press the SEL [F3] or Enter key to save the displayed value (changed or not) and advance to the next Run Options group parameter.



4.6.2: Delayed Start

By default, starting a sampling program will immediately initiate its interval timers. If it is set up to draw samples at one hour intervals, for example, the first will be taken one hour after the program is started. You can configure it to wait longer than that by setting a non-zero start delay. Other methods of delaying the first sample are to use the Float Enable parameter (see below), schedule regular automatic Start Events (see page 57), or manually set up one-time Timed Starts (see page 64).

To view and optionally change this setting:

1. Accept or change the Auto Rerun setting, which will display this parameter's current value.
2. If desired, type a new delay duration by pressing the corresponding numeric keys. When you type the first digit, the old value is erased and the F1 prompt changes from HOME to UNDO. You can then press the UNDO [F1] key to start over, or the BACK [F2] or Back key to delete the most-recently typed digit.
3. Press the SEL [F3] or Enter key to save the displayed value (changed or not) and advance to the next Run Option group parameter.

To change the start delay to 360 minutes, for example:



4.6.3: Fault Option

This parameter specifies whether the optional alarm relay (see page 88) should energize when the sampling program is waiting to be reset (whether it completed normally, was manually stopped, or detected a fault) or is continuing to run despite have detected a non-fatal fault.

To view and optionally change this setting:

1. Accept or change the Delayed Start setting to will display this parameter's current value.
2. If desired, press the Up or Down key to toggle it on or off, then press the SEL [F3] or Enter key to save the displayed value (changed or not) and advance to the next Run Options group parameter:



4.6.4: Float Option

This parameter configures the program to suspend sampling until its float input circuit is closed and subsequently either continue or pause sampling if it reopens (see page 90).

To view and optionally change its value:

1. Accept or change the Fault Option setting, which will display this parameter's current value.
2. If desired, press the Up or Down key to toggle it on or off, then press the SEL [F3] or Enter key to save the displayed value (changed or not) and advance to the next Run Options group parameter.

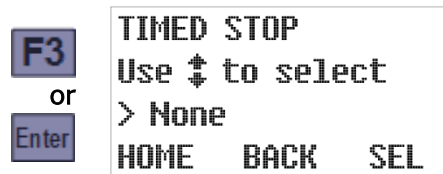
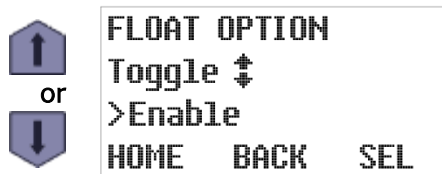

4.6.5: Timed Stop

This parameter configures the program to automatically stop a specified number of hours or minutes after it initiates its interval timers. To view and optionally change its value:

1. Accept or change the Fault Option setting, which will display this parameter's current value.
2. If desired, press the Up or Down key to scroll to the desired value, then press the SEL [F3] or Enter key to save that value (changed or not). Selecting any option other than Custom will save that value and display the next Run Option parameter's current value:

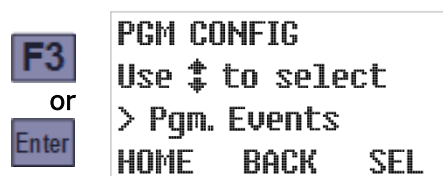
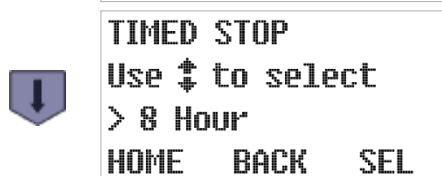
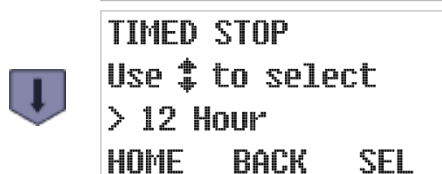



Selecting the Custom option displays a screen for setting the number of minutes the program will run before automatically stopping. The digit keys can then be used to change that setting, and pressing the SEL [F3] or Enter key will save the displayed value and display the next Run Option parameter's current value:



4.6.6: Bottle Limit Override

Each program's Bottle Options (see page 48) configure it to stop after discharging a specific number of samples into its composite sample container (or each of its discrete sample bottles), provided this parameter has its default "Program Stop" value. If you would prefer that the unit continue drawing samples indefinitely, without keeping track of how full the sample container is (or bottles are), you should instead set this parameter to "Program Continue":

1. Accept or change the Stop Time setting, which will display this parameter's current value.
2. If desired, press the Up or Down key to toggle between its two possible values, then press the SEL [F3] or Enter key to save the displayed value (changed or not) and return to the Program Configuration menu.



4.7: Program Events

Each program's scheduled events (see page 100) are defined by a list that can be accessed via the **Program Events** group. Each event on that list has three associated values:

- the type of event (start, stop, pause, halt, resume or manually sample),
- the days of the week on which the event will be executed, and
- the time of day on those days at which the event will be initiated.

Events are consecutively numbered as they are defined, so the event numbers shown when you review the list do not indicate the order in which those events will be executed. You cannot directly access a particular event's settings, add a new event without reviewing those already on the list, or delete an event without deleting all higher numbered events as well. But you can disable an existing event (by setting it to execute on no days of the week), or replace it by changing any or all of its three settings (type, days and/or time).

4.7.1: Reviewing Scheduled Events

When you access the Program Events group, it will initially display the event type for the first event on the list (which will be **End List** if there are none). Repeatedly pressing the Enter key will then display the remaining settings for that event, followed by the settings for the second event, and so on until you reach the first undefined event (whose type will be End List).

To review the event schedule:

1. Select the program you want to schedule events for (see page 33):

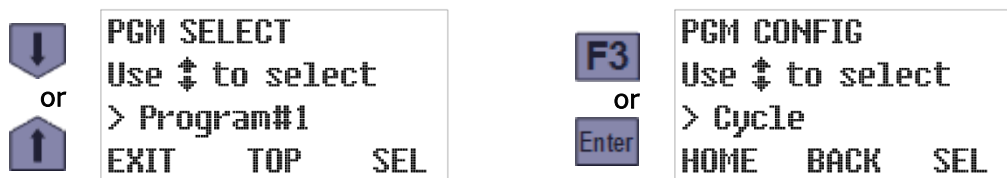

2. Press the Up key to scroll to the Program Events group, then press SEL [F3] or the Enter key to display the type of the first scheduled event (**Start Time** in the example below):



3. Press the Enter key to view that event's days setting, and again to view its time setting:



The second line of the WEEKDAYS screen displays seven letters representing the days of the week, while the third displays bullets indicating the days (if any) on which the event will occur—Monday through Friday in the example to the left above.

Similarly, the second line of the EVENT TIME screen displays the program's 24-hour time (a.k.a. military) time format while its third line indicates the time on those days at which this event will be initiated—2:00 PM (1400 hours) in the example to the right above.

- Continue pressing the Enter key repeatedly to review each event in turn. You can also re-examine previously-viewed screens by repeatedly pressing the Back key.
- After you have reviewed the last listed event, the readout will indicate you have reached an event assigned the End List type. You can then press the Event key again to return to the Program Configuration menu, or add a new event to the end of the list (see below).

```
PGM EVENT #8
Use ↓ to select
>End List
HOME  BACK  SEL
```

Enter

```
PGM CONFIG
Use ↓ to select
> Pgm. Events
HOME  BACK  SEL
```

4.7.2: Adding and Editing Events

Entirely new events can only be added to the end of the list, by changing the placeholder **End List** event that is displayed after you review the last existing event (see above). However, you might be able to effectively add a new one by editing a disabled event (see page 61). *In either case, there is no procedural difference between adding and editing an event.*

- Navigate to the **Program Events** group and access its End List event as described above:

```
PGM CONFIG
Use ↓ to select
> Pgm. Events
HOME  BACK  SEL
```

F3

or

Enter

```
PGM EVENT #1
Use ↓ to select
>End List
HOME  BACK  SEL
```

This example assumes no events have yet been set up. If any have, you must review them (see above) in order to access the End List event. While doing so, you can verify that the event has not been set up previously and make sure it would not be better to create it by rescheduling or otherwise editing an existing event.

- Use the Up or Down key to scroll to the desired event type (Start Time, for example), then press SEL [F3] or the Enter key to save that selection and display the Weekdays screen:

repeat either
↑
↓

```
PGM EVENT #1
Use ↓ to select
>Start Time
HOME  BACK  SEL
```

F3

or

Enter

```
WEEKDAYS #1
SMTWTFS ↓⓪
ESC ◀ ▶
```

- The third line includes an underline cursor that can be moved to a different day by pressing the Previous [F2] or Next [F3] key:

F3 F3

```
WEEKDAYS #1
SMTWTFS ↓⓪
ESC ◀ ▶
```

F2

```
WEEKDAYS #1
SMTWTFS ↓⓪
ESC ◀ ▶
```

4. Pressing the Up or Down key will toggle execution on the cursor-selected weekday on or off, as indicated by the arrows prompt at the end of the second line:

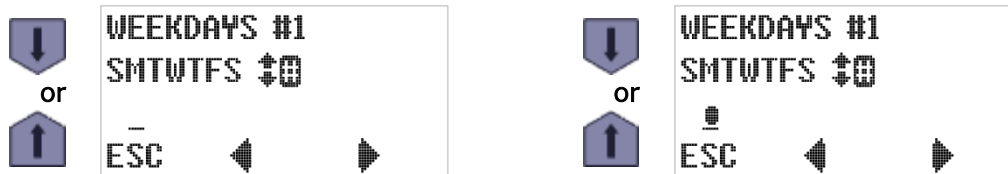

5. You can schedule an event to occur on a specific set of days by pressing the 7 (all days), 0 (no days), 2 (Saturday and Sunday only), or 5 (Monday through Friday) key—as hinted by the hash tag/number sign prompt at the end of the second line:

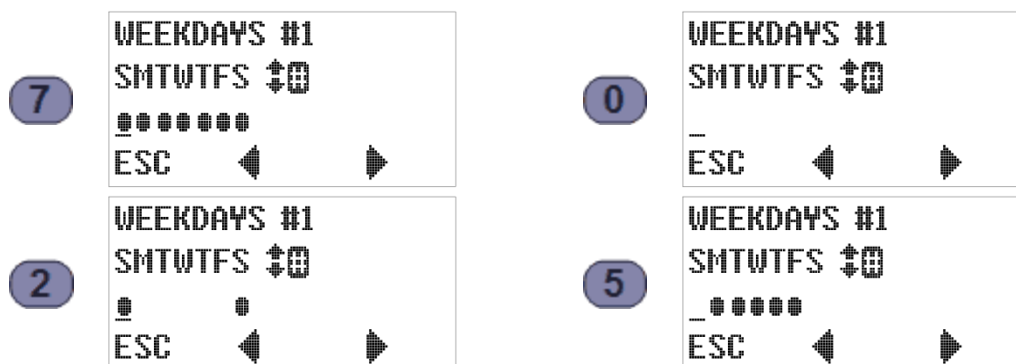

6. Pressing the ESC [F1] key cancels any change(s) you have tentatively made to this setting (but not any changes made to the current event's other settings) and restores the parent Program Event screen. For example:

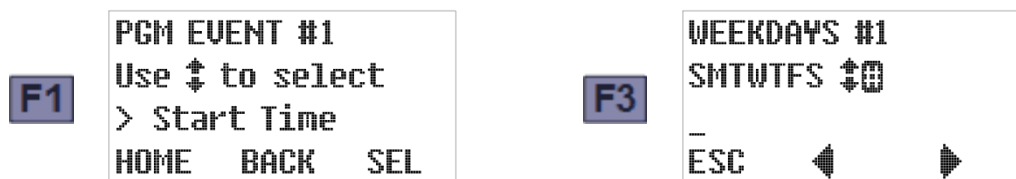

7. Pressing the Enter key saves the weekdays setting and displays the Event Time screen:

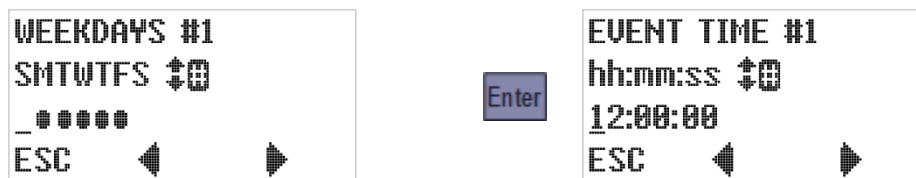

Again, an underline cursor indicates the digit currently subject to editing:

- Press the Previous [F2] or Next [F3] key to move that cursor one digit left or right.
 - Press any appropriate numeric key to set the current digit and advance the cursor, OR press the Up or Down key to increment or decrement the current digit (either action is recognized only if a valid time results).
 - Press the ESC [F1] key to undo any change to the displayed time and return to the Weekdays screen.
8. Pressing the Enter key saves the indicated time setting and displays the first screen for the next Program.

4.7.3: Deleting Events

Events can be deleted only from the end of the list—by reviewing the settings for each event you want to keep and then changing the type of the first one you want to delete to **End List**.

✎ *An event could effectively be removed from the middle of the list by disabling it, as described in the next topic.*

For example, if there were eight listed events and you wanted to delete all but the first two:

1. Access the **Program Events** group as described above:

| | | |
|--|---|---|
| <pre>PGM CONFIG Use ↓ to select > Pgm. Events HOME BACK SEL</pre> | <div style="border: 1px solid black; padding: 2px; display: inline-block;">F3</div> or <div style="border: 1px solid black; padding: 2px; display: inline-block;">Enter</div> | <pre>PGM EVENT #1 Use ↓ to select > Start Time HOME BACK SEL</pre> |
|--|---|---|

2. Press the Enter key repeatedly until the first Event #3 screen appears, then use the Up or Down key to scroll to the End List event type:

| | | | | |
|--|---|---------------|--|--|
| <div style="border: 1px solid black; padding: 2px; display: inline-block;">Enter</div> repeat until | <pre>PGM EVENT #3 Use ↓ to select >Stop Time HOME BACK SEL</pre> | repeat either | <div style="border: 1px solid black; padding: 2px; display: inline-block; text-align: center;">↑</div> or <div style="border: 1px solid black; padding: 2px; display: inline-block; text-align: center;">↓</div> | <pre>PGM EVENT #3 Use ↓ to select >End List HOME BACK SEL</pre> |
|--|---|---------------|--|--|

3. Finally, press SEL [F3] or the Enter key to delete this and any higher-numbered events:

| | |
|---|--|
| <div style="border: 1px solid black; padding: 2px; display: inline-block;">F3</div> or <div style="border: 1px solid black; padding: 2px; display: inline-block;">Enter</div> | <pre>PGM CONFIG Use ↓ to select > Pgm. Events HOME BACK SEL</pre> |
|---|--|

4.7.4: Disabling Events

You can disable an event without deleting it (so you could later re-enable it), or effectively delete an event from the middle of the list, by configuring it to occur on no days of the week. For example, if there are four or more defined events but you no longer want the third one to execute:

1. Access the **Program Events** group as previously described:

```
PGM CONFIG
Use ↓ to select
> Pgm. Events
HOME  BACK  SEL
```

F3
or
Enter

```
PGM EVENT #1
Use ↓ to select
> Start Time
HOME  BACK  SEL
```

2. Press the Enter key repeatedly until the first Event #3 screen appears. The displayed event type will be irrelevant once the event has been disabled, so you need only press SEL [F3] or the Enter key to display its WEEKDAYS screen:

Enter
repeat until

```
PGM EVENT #3
Use ↓ to select
>Stop Time
HOME  BACK  SEL
```

F3
or
Enter

```
WEEKDAYS #3
SMTWTFS ↓0
●●●●●●
ESC  ←  →
```

3. Press the 0 (zero) key to deselect all days of the week, then press the Enter key to save that change and display the event's execution time:

0

```
WEEKDAYS #3
SMTWTFS ↓0
-
ESC  ←  →
```

Enter

```
EVENT TIME #3
hh:mm:ss ↓0
12:00:00
ESC  ←  →
```

4. The time setting will also be irrelevant given that execution has been disabled for every weekday. So you need only press the Enter key to display the next event's type screen, from which you can exit the Program Events group by pressing HOME [F1]:

Enter

```
PGM EVENT #4
Use ↓ to select
>Pause Program
HOME  BACK  SEL
```

F1

```
PGM CONFIG
Use ↓ to select
> Pgm. Events
HOME  BACK  SEL
```

Chapter 5: Sampler Operation

Although All-Season Samplers require little or no operator intervention (see page 12), their user interface panels can be used to:

- select a different sampling program (see page 33)
- start the indicated program (see page 64)
- monitor the program while it is running (see page 67)
- manually collect unscheduled samples (see page 70)
- pause and resume sample collection (see page 71)
- stop and reset the sampling program (see page 73)
- review archived sample collection data (see page 74)

That interface (see below) is mounted below the upper shell's upper-front hatch and consists of a keypad and a four-line LCD readout:

- The readout's top line identifies the selected program and displays its operating state.
- Its second and third lines display sets of status information you can cycle through by pressing the Up or Down keys to the right of the readout.
- Its bottom line indicates the functions of the F1, F2 and F3 keys.





In addition, any of the icons listed in Table 5-1 might be displayed along its right edge.

Table 5-1: User Interface Panel and Icons

| | | |
|--|--|---|
| | | program is running (see page 67) |
| | | program is paused (see page 71) |
| | | program will automatically start at a specific time (see pages 66 and 65) |
| | | program will automatically stop at a specified time (see page 73) |
| | | sequential sampling turntable is rotating (see page 68) |
| | | sampling cycle is being repeated (see page 70) |
| | | non-fatal fault (see page 64) |
| | | arrow up: float switch is closed arrow down: float switch is open (see pages 65 and 72) |
| | | power supply voltage level (see page 64) |

5.1: Ready State

The LCD's top line identifies the selected program and its operating state, which is "READY" while it is waiting to be started. The second and third lines display sets of additional information you can scroll through using the Up and Down keys:



| | | |
|--|---|---|
| <p>If set for Time+Flow intervals, the elapsed Time and Gallons or Time and Pulses will be shown. If not, only one of them will.</p> | <pre>Pgm1 : READY Time (min.): 60 > 0 : 0% RUN TIMED MENU</pre> | <p>Program 1 is set to sample at timed intervals. The first one will be drawn 60 minutes after the program is started.</p> |
| | <pre>Pgm1 : READY Gallons : 2500 > 0 : 0% RUN TIMED MENU</pre> | <p>Program 1 is set to sample at flow meter volume intervals. The first one will be drawn 2500 gallons after the program is started.</p> |
| | <pre>Pgm1 : READY Pulses : 600 > 0 : 0% RUN TIMED MENU</pre> | <p>Program 1 is set to sample at flow meter pulse intervals. The first one will be drawn 600 pulses after the program is started.</p> |
|  | <pre>Pgm1 : READY Smp1:#1 12:34:56 07/08/15 RUN TIMED MENU</pre> | <p>The next sample drawn will be the first. The current time is 12:34:56. The current date is July 8, 2015.</p> |
|  | <pre>Pgm1 : READY Comp: 5 gal. Smp1#: 0 of 168 RUN TIMED MENU</pre> | <p>Program 1 is set to discharge 168 samples into a 5 gallon container.</p> |
|  | <pre>Pgm1 : READY Bot1#1: 24 500 Smp1#: 0 of 4 RUN TIMED MENU</pre> | <p>OR</p> <p>Program 1 is set to discharge 4 samples into each of up to 24 500 milliliter bottles</p> |
|  | <pre>Pgm1 : READY Temp.: 4.2 °C Power: 15.6 V RUN TIMED MENU</pre> | <p>The current sample storage compartment temperature is 4.2 degrees Celsius and the control system power supply or connected battery is providing 15.6 Vdc power</p> |

When the program is waiting to be started:

- Pressing the RUN [F1] button starts it immediately.
- Pressing the TIMED [F2] button allows you to set the date and time at which it will start.
- Pressing the MENU [F3] key will activate the menu system, from which you could select a different program (see page 33).

5.2: Sampler Conditions

The approximate control system power supply voltage is always indicated by a battery icon in the upper right corner of the user interface readout, and you can always scroll to a screen that displays that voltage and the current sample storage compartment temperature:

| | | |
|---|----|---|
| <pre>Pgm1 : READY  Temp.: 42 °C Power: 15.6 V RUN TIMED MENU</pre> | OR | <pre>Pgm1 : RUNNING  Temp.: 42 °C Power: 15.6 V STOP MAN PAUSE </pre> |
|---|----|---|

A fault icon will also be displayed if any of the following fault conditions exists:

- sampling has been suspended because the float input circuit is open;
- the most recent sample cycle failed to trigger the liquid sensor, potentially indicating that sample was smaller than intended; or
- the storage compartment has been above its intended temperature for at least 30 minutes (this will also be indicated by displaying a °C icon).

Those conditions will also energize the Alarm Relay (if enabled), which is also energized when the program is waiting to be reset after completing normally, being manually stopped, or failing to determine the position of the sequential-sampling turntable.



5.3: Starting the Selected Program

When the control system is in its Ready state:

- Pressing the RUN [F1] key starts the selected sampling program immediately. However, it might not begin sampling until a time delay elapses, a bottle-full or stream-level float switch is closed, or a scheduled time arrives.
- Pressing the TIMED [F2] key allows you to set a timer that starts that program at a specified time and date (see Timed-Delay Starting below). Any configured time or float-input delay would further delay the first sampling interval.
- Pressing the MENU [F3] key will activate the menu system (see 25). You could then select a different program using the Program Menu (see page 33), although you might first need to enter the administration password (see page 25).

5.3.1: Timed-Delay Starting

The interval counter(s) will not start until the start delay (if non-zero) has elapsed. In the meantime, the operating state will display as DELAYED and the first information screen will indicate the progress of that delay:

| | | | |
|---|---|-----------------------|--|
|  | <pre>Pgm1 : DELAYED Delay (min.): 60 > 12 : 20% STOP MAN PAUSE</pre> | when delay elapses | <pre>Pgm1 : RUNNING Time (min.): 60 > 0 : 0% STOP MAN PAUSE </pre> |
|---|---|-----------------------|--|

5.3.2: Float-Delayed Starting

If the float input is enabled (see page 55), the sampling program will not start its interval counter(s) until the float-switch circuit is closed (see page 90). Those counter(s) will remain at zero as long as the float icon points down and start accumulating when it points up (think of this icon as a thumbs-up or thumbs-down indicator):

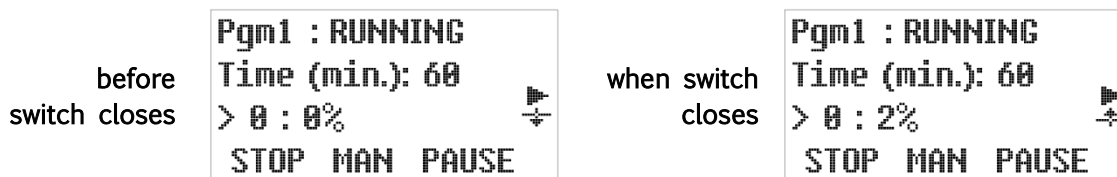

Depending on which of the Factory Menu float input options is enabled, the sampler will subsequently either continue or suspend sampling (see page 72) if the float-switch circuit subsequently reopens. Composite CVE samplers use the float input to determine whether or not the sample container is full, and suspend sampling when it is (see page 72).

5.3.3: Timed Starting

The selected program can also be started by pressing the TIMED [F2] key, which displays the first of two screens from which you specify the date and time at which you want it to start:

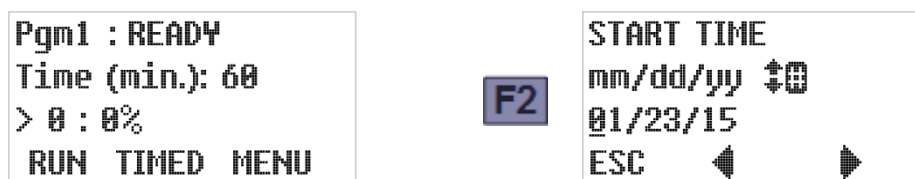

That screen initially displays today's date. Leave it unchanged or:

- Press the Previous [F2] or Next [F3] key to move the underline cursor (which initially selects the first digit of the month for editing) one digit left or right.
- Press the appropriate numeric key to set the selected digit and automatically move the cursor to the right, OR
Press the Up or Down key to increment or decrement that digit, then press the Previous [F2] or Next [F3] key to manually move the cursor.
- Press the ESC [F1] key to cancel the Timed Start and return to the Ready state screen.

Once the desired start date has been set, press the Enter key to save it and display the screen for specifying the time of day at which the program should start. That screen initially shows the current time, which can be changed using the same methods as the date. Use F2 and F3 to select a digit you want to change, then press the Up or Down arrow or a numeric key to change that digit as desired. Finally, press Enter to initiate the TIMED operating state discussed in the following section:



5.3.3.1: Timed State

The Timed operating state is entered when the selected program is:

- set to start at a specified time and day (see previous section), or
- configured to start (or restart) at scheduled times on specified days of every week and then manually started by pressing the RUN [F1] key (see next section).

The run-time screens will then display a clock icon and you can scroll to an additional screen that shows the time and date at which the interval counters will start. The following example of that screen indicates sampling will begin in approximately two days:

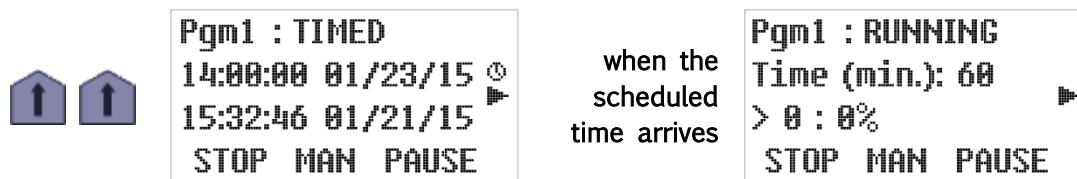

When that time arrives, the program proceeds as if you had just pressed the RUN [F1] key:

5.3.4: Scheduled Starting

Each program can be configured to start (or restart) at scheduled times on specified days of every week. Manually starting such a program will initiate its Timed operating state (see above). When the scheduled time arrives, the program will proceed as if you had just pressed the RUN [F1] key.

When that program completes or is stopped, it will have to be reset before the next start event can restart it unless it is also configured for automatic restarting. If it is, it will instead reset itself and then enter its Auto Rerun state, which is identical to the Timed state described above except the displayed state would be AUTO RERUN instead of TIMED:



When this screen first appears, the sample containers should be replaced with empties.

5.4: Running State

Once the selected program has initiated its sampling-interval counters, the readout's top line displays its operating state as "RUNNING". The second and third lines display scrolling sets of additional information similar to those available in the Ready state:

If set for Time+Flow intervals, the elapsed Time and Gallons or Time and Pulses will be shown. If not, only one of them will.

```
Pgm1 : RUNNING
Time (min.): 60
> 25 : 42%
STOP MAN PAUSE
```

Program 1 is sampling at timed intervals. The next one will be drawn after a 60 minute interval that started 25 minutes ago (42 percent elapsed).

```
Pgm1 : RUNNING
Gallons : 2500
> 1048 : 42%
STOP MAN PAUSE
```

Program 1 is sampling at measured flow intervals. The next one will be drawn after a 2500 gallon interval that started 1048 gallons ago (42 percent elapsed).

```
Pgm1 : RUNNING
Pulses : 600
> 253 : 42%
STOP MAN PAUSE
```

Program 1 is sampling at flow meter pulse intervals. The next one will be drawn after a 600 pulse interval that started 253 pulses ago (42 percent elapsed).

```
Pgm1 : RUNNING
Smp1:#4
12:34:56 07/08/15
STOP MAN PAUSE
```

The next sample will be the fourth (#4) drawn by the current program run. The current time is 12:34:56. The current date is July 8, 2015.



sample container screens (see page 68)



start timer (see page 64) or stop timer (see page 73) screen



```
Pgm1 : RUNNING
Temp.: 4.2 °C
Power: 15.6 V
STOP MAN PAUSE
```

The current sample storage compartment temperature is 4.2 degrees Celsius and the control system power supply or connected battery is providing 15.6 Vdc power

When the indicated program is running, the top row keys are assigned the following functions:

- Pressing F1 will immediately stop the program (see page 73).
- Pressing F2 will immediately trigger the collection of a manual sample (see page 70).
- Pressing F3 will pause the sampling (see page 71).

5.4.1: Sampling Intervals

As shown on the previous page, the second and third lines of the primary run-state readout will depend on whether the selected program is configured to draw samples at the end of elapsed time (minutes) or stream flow (gallons or pulses) intervals.

If the program has been configured to sample at the ends of flow intervals with a time limit, both screens will be displayed—you can then use the Up and Down keys to scroll between them. When either interval counter reaches 100 percent, both counters will be reset as an automatic sampling cycle is initiated.



5.4.2: Sample Container Screens

The following run-state screens indicate which containers are installed and how full they are:

- This screen is for a composite-sampling 5 gallon container:

```
Pgm1 : RUNNING
Comp: 5 gal.
Smp1#: 7 of 168
STOP MAN PAUSE
```

Seven of the 168 samples the program is configured to deposit into its 5 gallon container have been collected so far.

- This screen is for a sequential sampling system with 24 500 ml bottles:

```
ru
Pgm1 : RUNNING
Bot1#1: 24 500
Smp1#: 2 of 4
STOP MAN PAUSE
```

Bottle #1 is positioned to receive the next sample, which will be the 3rd of the 4 that will be put into that bottle.

A broken-arrow icon along the right side indicates the carousel is being rotated to the indicated bottle. The program will stop and set its alarm relay if it cannot operate the turntable or determine its position:

```
Pgm1 : RUNNING
Bot1#2: 24 500
Smp1#: 0 of 4
STOP MAN PAUSE
```

if unable to
rotate to
intended
position

```
Pgm1 : ERROR
Indexing Table
Index Error
RESET
```

If the program is configured to advance the carousel at specified time intervals, you can also scroll to an additional run-time screen displaying the progress of the current interval:

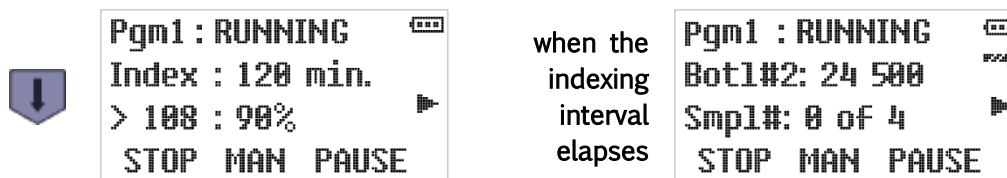

when the
indexing
interval
elapses

5.4.3: Sampling Cycle

Figure A-2 on page 92 illustrates the full CVE-16 sampling cycle, which can be configured to include up to four optional **line rinse** and an optional **line pre-purge**. When the running program triggers that cycle (or a manual sample is initiated), the optional Run-Status output is set, the displayed state will change to “SAMPLING” and the second and third lines of the readout will report the progress of the sampling cycle (which requires no operator participation):

- If line rinsing is disabled, the program will simply purge the sampling line before suctioning in the intended sample.
- Otherwise, each enabled rinse first blows the line clear and then partially fills it with wastewater. The sample is drawn after the line is purged to complete the final rinse.

| | | |
|--|--|--|
| when the sample is initiated | <pre>SAMPLING rinse press... sec: 14 STOP</pre> | These two screens are displayed only if one or more optional rinse cycles have been set up. |
| followed by | <pre>SAMPLING rinse vac... sec: 10 STOP</pre> | |
| when the final rinse (if any) is completed | <pre>SAMPLING prepurge... sec: 12 STOP</pre> | Any accumulated or rinse water is blown out of the intake line. |
| prepurge counts down, then | <pre>SAMPLING size: 80 sec. sec: 16 STOP</pre> | Wastewater is drawn into the chamber until it reaches the liquid-sensor electrodes. If recycling is enabled (see page 70), it will be triggered if this timer elapses. |
| sampling time counts down, then | <pre>SAMPLING postpurge... sec: 25 STOP</pre> | Excess water is blown back out of the sampling chamber (down to the bottom of the intake tube) and intake line is blown clear. |
| postpurge counts down, then | <pre>SAMPLING discharge... sec: 12 STOP</pre> | The pinch valve is opened so the sample can drain (under slight pressure) into its intended container. |
| discharge time counts down, then | <pre>Pgm1 : RUNNING Time (min.): 60 > 3 : 5% STOP MAN PAUSE</pre> | The Running state readouts are restored (the interval counter was restarted when the sample was initiated). |

5.4.3.1: Incomplete Sample Recycling

If the sample seconds timer elapses before the chamber fills to the liquid-sensor level, a failed sample error will be indicated:

- If “recycling” is disabled, the error screen is displayed for only a few seconds, after which the line is purged and the incomplete sample is discharged.
- If it is enabled, a recycling icon is displayed while the prepurge and vacuum steps are repeated. When the chamber finally fills, or the fourth recycle fails, the line is purged and the sample is discharged.

| | | | |
|-------------------------------------|---|-------------------------|---|
| if the liquid sensor is not reached | <pre>SAMPLING failed sample resetting... STOP</pre> | If recycling is enabled | <pre>SAMPLING failed sample please wait... STOP</pre> |
| when sample is completed or aborted | <pre>SAMPLING postpurge... sec: 25 STOP</pre> | post-purge counts down | <pre>SAMPLING discharge... sec: 12 STOP</pre> |

5.4.3.2: Manual Sampling

Pressing the MAN [F2] key while the selected program is running will trigger the immediate collection of an unscheduled sample using the configured sampling cycle discussed above:

| | | |
|--|---|---|
| <pre>Pgm1 : RUNNING Time (min.): 60 > 25 : 42% STOP MAN PAUSE</pre> | <div style="background-color: #4a7ebb; color: white; padding: 2px 5px; display: inline-block;">F2</div> | <pre>SAMPLING rinse press... sec: 14 STOP</pre> |
| or | | |
| <pre>SAMPLING prepurge... sec: 12 STOP</pre> | | |

That sample will be discharged to the bottle meant for the next automatic sample, and counted toward the number of samples the program is configured to put into that bottle. If that fills the bottle, the next one will be rotated into place (sequential-sampling units) or the program will be stopped (composite-sampling units).

If an automatic sample would otherwise have been triggered during the manual cycle, the following screen will be briefly displayed:

```
SMPL. INTERVAL
Sample Blocked
>Wait
ESC
```

Blocked samples ARE NOT DRAWN when the manual sample is completed.

5.5: Paused and Halted States

If you press the PAUSE [F3] key while a program is running, it will immediately enter its PAUSED state. Programs can also be configured to automatically pause and resume at scheduled times.

While the program is paused, the run icon is replaced by a paused icon. The sampling interval will continue to accumulate, but no samples will be taken until the RUNNING state is restored by pressing the RESUME [F3] key:

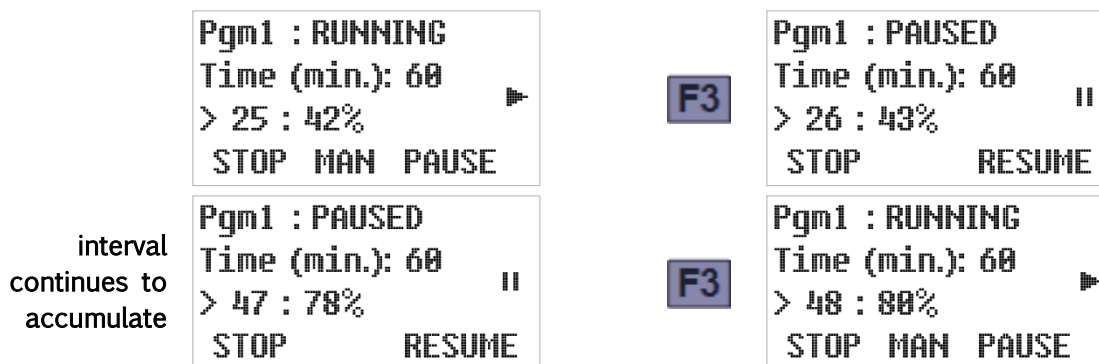

Programs can also be configured to halt and resume at scheduled times. The resulting Halted state is similar to the Paused state, except that any configured flow intervals will not continue to accumulate.

While the program is halted, the running icon is replaced by a halted icon (as shown below). The Running state is often automatically restored at a scheduled time, but in any case can be manually restored by pressing the RESUME [F3] key:

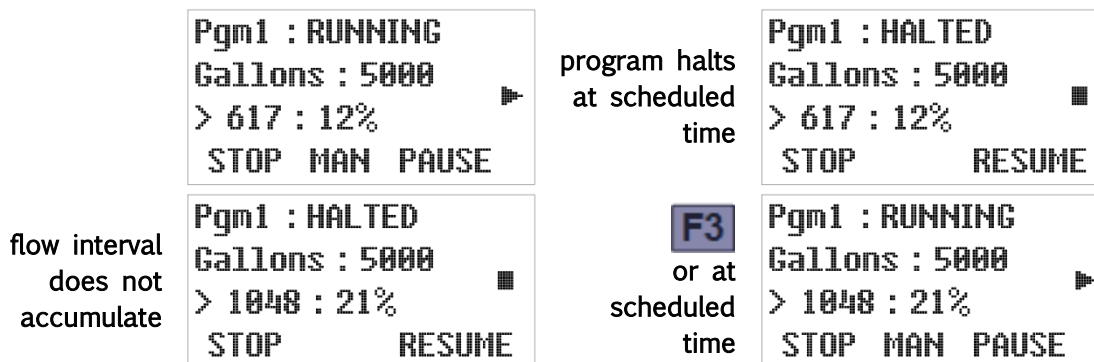

You can stop the program or take manual samples while automatic sampling is paused or halted. If the configured sampling interval reaches 100 percent one or more times, the following screen will briefly appear:

```
SMPL. INTERVAL
Sample Blocked
>Wait
ESC
```



⚡ *Blocked samples are not drawn when the paused or halted program is resumed.*

5.5.1: Float Suspended Sampling

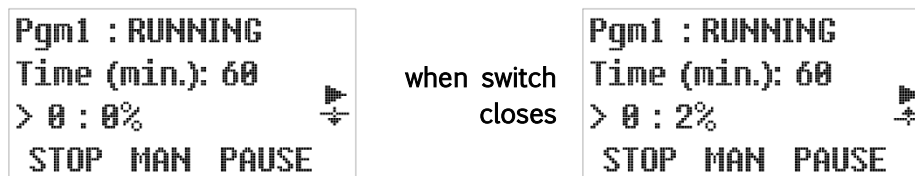
If the Float Option (see page 55) is enabled and factory-configured (see page 90) to suspend sampling when that input is cleared, the interval counters are held at zero whenever the float switch is open:



Note that the float icon points down when the float-switch circuit is open (sampling suspended) and up when that circuit is closed (sampling resumed). This can be remembered by thinking of this icon as a thumbs-up or thumbs-down indicator:

-  indicates the stream depth is insufficient to sample or the composite container is full
-  indicates the stream depth is sufficient to sample or the container is not full

5.6: Stopping the Program

The running program might have been set up to take a specific number of samples and then stop, in which case it would then display its DONE operating state screen:

| | | |
|---|--|--|
| <pre>Pgm1 : RUNNING Comp: 5 gal. Smp1#: 167 of 168 STOP MAN PAUSE</pre> | <p>after final sample is drawn</p> | <pre>Pgm1 : DONE >Pgm Complete >Normal RESET</pre> |
|---|--|--|

Prior to resetting the program, you can scroll to the other run-time screens. For example, you could to the screen that tells how many samples were collected.

Alternately, it might have been set to only run for a specified length of time or to stop at a specific, scheduled time. If so, it displays a timed stop icon above the running icon (as shown below) and you can scroll to an added RUNNING screen whose second line shows the time and date at which the program will shut down and display the DONE operating state screen:

| | | | |
|---|--|--|--|
|  | <pre>Pgm1 : RUNNING 18:00:00 07/09/15 12:34:56 07/08/15 STOP MAN PAUSE</pre> | <p>when scheduled time arrives</p> | <pre>Pgm1 : DONE >Pgm Complete >Normal RESET</pre> |
|---|--|--|--|

In either case, the program can be prematurely stopped by pressing the STOP [F1] key, after which it would display its STOPPED screen:

| | | | |
|---|---|---|--|
|  | <pre>Pgm1 : STOPPED >Pgm Stopped >From Keypad RESET</pre> |  | <pre>Pgm1 : READY Time (min.): 60 > 0 : 0% RUN TIMED MENU</pre> |
|---|---|---|--|

The RESET prompt indicates you cannot restart the program until you press the F1 key to zero its interval and container volume counters and advance it to its READY state.

5.6.1: Continuous Operation

If the Bottle Limit option (see page 56) is set to “Program Continue”, the program will ignore its samples per bottle setting and continue sampling indefinitely, without requiring anyone to ever press the RESET [F1] key.

As the sampling program has no way of knowing how many samples it has discharged since the container was last emptied, the sample count screen (see page 68) merely indicates “NL” (no limit). However, a composite sampler would still suspend sampling if its bottle-full float switch ever opened, restarting its interval counter(s) when the container was replaced:

| | | |
|---|---|--|
| <pre>Pgm1 : RUNNING Smp1#:NL 12:34:56 07/08/15 STOP MAN PAUSE</pre> | <p>if composite container filled up</p> | <pre>Pgm1 : RUNNING Time (min.): 60 > 0 : 0% STOP MAN PAUSE</pre> |
|---|---|--|

5.7: Reviewing Archived Data

As discussed on page 101, samplers manufactured since mid-March of 2016 store timestamped records of each sample they draw, separated into individual log files for each sampling run (i.e., one log file for each time any sampling program has been run).

That archived data can be reviewed from the user interface panel by pressing the 5 key when the selected program is running (or waiting to be started), but not while the Administration or Program menu is active. The first line of the resulting display will indicate you are viewing log file 1, in which data for the current (or pending) sampling run is being (or will be) recorded:

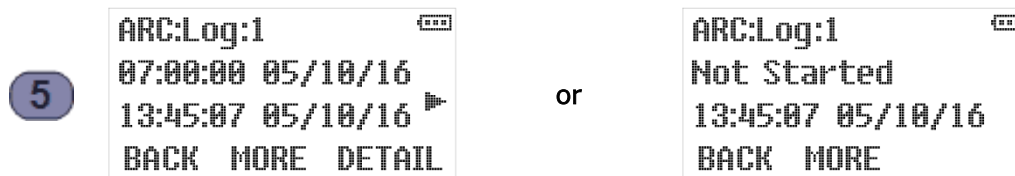

The second line of that display indicates the date and time at which the selected program was started, while the third line displays the date and time at which you started viewing its log file. For example, the screen shown to the left above indicates the currently running program was started at 7:00 AM on May 10, 2016, and the data archive was opened at about 1:45 PM that same day. If the program had not yet been started, the screen shown to the right above would be displayed.

- ✎ *The icons along the right edge of the screen will continue to indicate the current status of the selected program (see Table 5-1 on page 62 **Error! Bookmark not defined.**).*
- ✎ *The **DETAIL** prompt for the F3 key appears only for log files that contain one or more sample and/or exception records.*

Pressing the Down arrow would then access the first log file screen for the second-most recent sampling run (log 2) and display the times and dates at which that sampling run was started and stopped. For example, the display shown to the left below indicates the prior sampling run was initiated at 7 AM on May 9, and concluded about 12 hours later:



You can use the Up and Down keys to scroll through the available log files. Pressing the Up key while viewing the newest will access the oldest, pressing the Down key while viewing the oldest will access the newest. The sample screen shown to the left below indicates 42 log files are currently available, the oldest of which was recorded on March 14, 2016:



- ✎ *Use the Administration Menu's **Clear Archive** option (see page 31) to erase the log files.*

Press the MORE [F2] key repeatedly to view the following additional information about each log:

| | | |
|-----------|---|---|
| F2 | <pre>ARC:Log:1 07:00:00 05/10/16 12 smp1s rc BACK MORE DETAIL</pre> | <p>number of samples collected (rc appears only if some samples required recycling)—this example indicates the sampling run that commenced at 7:00 AM on May 10 collected 12 samples]</p> |
| F2 | <pre>ARC:Log:1 Composite 1 5 gal. BACK MORE DETAIL</pre> | <p>type, number and size of the containers to which those samples were discharged</p> |
| F2 | <pre>ARC:Log:1 07:00:00 05/10/16 2 excepts BACK MORE DETAIL</pre> | <p>number of exceptions that occurred during that sampling run (the DETAIL prompt for the F3 key appears only if it is not zero)</p> |
| F2 | <pre>ARC:Log:1 07:00:00 05/10/16 2 recycs. BACK MORE DETAIL</pre> | <p>number of times the incomplete sample recycling feature was triggered during that sampling run (the DETAIL prompt for the F3 key appears only if it is not zero)</p> |

Pressing the DETAIL [F3] key while viewing any of a log file's first three screens will display the number of samples it deposited into its first (or only) sample container. For example:

| | | | |
|-----------|--|----|--|
| F3 | <pre>ARC:Bot:1 3 smp1s n1 NA rc BACK MORE DETAIL</pre> | or | <pre>ARC:Bot:1 12 smp1s n1 NA rc BACK DETAIL</pre> |
|-----------|--|----|--|

where the **rc** notation will be present on the third line only if the incomplete sample recycling feature was triggered for at least one of the samples deposited into that bottle. The left screen above is displayed by sequential samplers, in which case repeatedly pressing the MORE [F2] key would reveal how many samples were deposited into each of the other sample containers. The right screen, which does not display the MORE prompt, is displayed by composite samplers.

Pressing the DETAIL [F3] key while any sample container's screen is active would display the timestamp and programmed vacuum time for the first sample discharged to that container. You could then display the same information for each of the other samples in to that container by repeatedly pressing the Up and/or Down keys:

| | | | |
|-----------|--|---|---|
| F3 | <pre>ARC:B1:S1 08:00:00 05/10/16 15 sec BACK</pre> | ↑ | <pre>ARC:B1:S2 09:00:00 05/10/16 15 sec rc BACK</pre> |
|-----------|--|---|---|

The example screens shown above indicate the first two samples were drawn at 8:00 and 9:00 AM, respectively. The "rc" notation on the sample 2 screen indicates the sample chamber did not fully fill on the first attempt, thus triggering the incomplete sample recycling feature.

If a log file's fourth screen indicates one or more exceptions were encountered, pressing its DETAIL [F3] key will display the timestamp and type of the first such exception detected during that program run. For example:



where the screen shown to the left indicates that the program run that commenced at 7:00 AM on May 10 encountered two exceptions. The screen on the right indicates the first of them was an electrical power loss at about 9:25 AM on that same date.

If a log file's fifth screen indicates one or more samples required more than one vacuum phase to collect the intended volume, pressing its DETAIL [F3] key will display the record for the first such sample. You could then display the records for the other recycled samples by repeatedly pressing the Up and/or Down keys. For example:



where the screen shown to the left indicates two of our example program run's sample cycles needed more than one vacuum phase to fill the sample chamber. The screen on the right indicates the first such sample cycle was initiated at about 4:00 PM.

Chapter 6: Maintenance

All-Season Samplers are designed to be nearly maintenance free, but routine cleaning and temperature verification is advisable, thermostat adjustment might occasionally be needed, and some parts might eventually wear out. Failed parts can be returned to the factory for repair or replacement, or you can order replacement parts using the numbers listed in Appendix B:

6.1: Routine Maintenance

The only routine maintenance we recommend is to occasionally clean the sampler and verify the sample compartment temperature.

6.1.1: Cleaning the Sampler

In addition to immediately cleaning up any spilled wastewater, you should periodically clean the interior and exterior of the sampler:

- If any wastewater has been spilled into the sample compartment, it should be washed with soapy water, then rinsed and dried.
- The intake line and sampling chamber can be cleaned by drawing several samples from a bucket of warm, soapy water, followed by several more drawn from a bucket of warm rinse water (you might want to set up a program configuration to be used for this purpose). Replace the tubing and/or chamber if that process fails to remove all significant fouling.
- You might also want to occasionally wash and wax the exterior fiberglass shell to keep the unit looking like new.

In northern climates, remove any ice or snow that accumulates around the base of the unit, especially if it blocks the refrigeration module's external air vents.

6.1.2: Verifying the Temperature

The sample compartment temperature is displayed by the fifth operating state screen (see page 67), and periodically recorded in the archival data. Although that measurement is calibrated at the factory, it can drift over time. So a calibrated refrigeration thermometer should periodically be used to determine how close the sampler's measurement is to being accurate and how close the sample compartment is being kept to the desired temperature.

If the actual temperature differs unacceptably from its desired value, you will need to adjust the thermostat's set point up or down accordingly (see page 79).

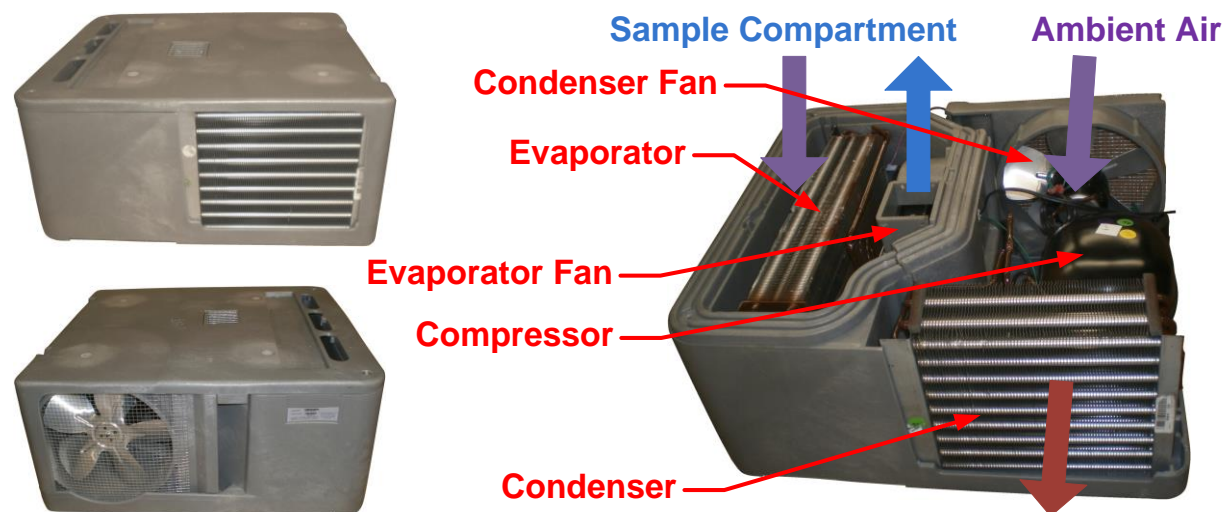

Figure 6-1: All-Weather Sampler Refrigeration Module

6.2: Refrigeration System Maintenance

The sampler's internal temperature is maintained by a packaged refrigeration module with an optional cold-climate heating element. Mounted in the lower shell, that module draws air from the back of the sample compartment, measures its temperature, cools (or heats) it as needed, and then returns it via ducts in the floor and sides of the upper shell. Ambient cooling air is drawn through the lower shell's left-side (viewed from the front) ventilation grill and blown out through the condenser and grill on the right side.

In excessively dusty environments, this module's efficiency might gradually decline due to condenser fouling—primarily on its inside surface. In such environments, you should occasionally remove the sampler's right grill and *spray low-pressure water* through the condenser to rinse accumulated dust from its coils and fins (the water will drain out the bottom of the module).



Do not operate the unit with the sample compartment door and/or interface panel open or unlatched. Doing so can allow excess moisture into the conditioned space, which would then condense and freeze within the refrigeration module. Eventually, that could reduce its ability to maintain the desired temperature or even choke off the air flow through the sample compartment.

Modules exhibiting any other problems should be returned to QCEC for repair or replacement. Spare/replacement refrigeration modules and thermostats are available from QCEC, component-level repair parts are not.

All copper tubing in the refrigeration module is coated with a phenolic resin to resist hydrogen sulfide (H_2S) corrosion. However, the high concentrations of that gas present in some areas of a wastewater treatment facility can still create pin-hole leaks after as little as a year or two of exposure. Therefore, *refrigeration failures caused by excessive H_2S exposure are not covered by QCEC's standard two-year warranty.*

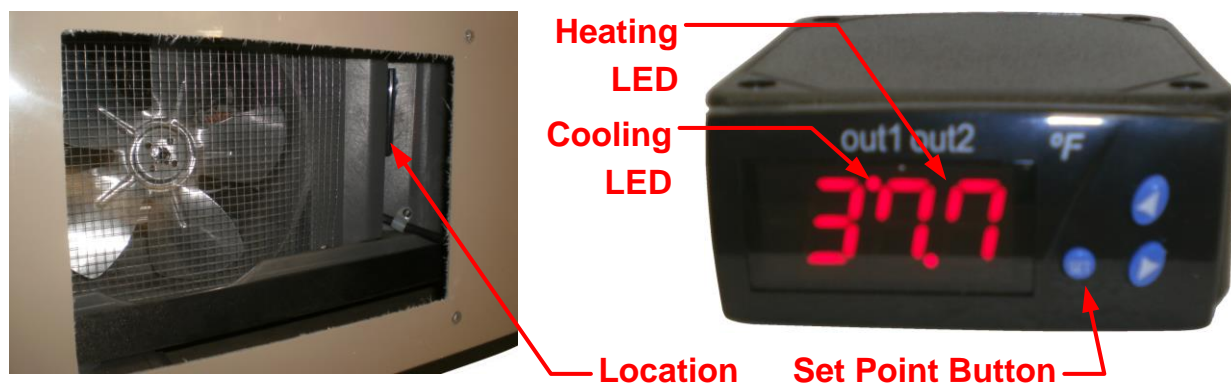

Figure 6-2: Refrigeration Module Thermostat

6.2.1: Adjusting the Thermostat

The sample compartment temperature is regulated by a thermostatically-controlled refrigeration module, which cools and optionally heats the air it constantly circulates through the sampler to keep it at the EPA-recommended temperature of 4.0°C (39.2°F). Its set points should be adjusted if the actual temperature determined using a calibrated refrigeration thermometer drifts from its intended value over time, or if you need to keep your samples at a different temperature.

The thermostat is mounted on the left side of the refrigeration module, and can be accessed by removing the left ventilation grill (as shown above). However, adjusting its set points without removing the module from the sampler is at best difficult.

Its numerical readout normally displays its temperature measurement, in degrees Fahrenheit. The **out1** LED at the top of that readout (between the first and second digits) lights when it turns on the refrigeration compressor, while the **out2** LED (between the second and third digits) lights when it turns on the heating element.

The thermostat has two set points, one for cooling and one for heating:

- Out1 is energized if the temperature rises more than 3 Fahrenheit degrees above the cooling set point and de-energized when it is reduced back to that set point. It is factory set to 37.7°F, so the refrigeration compressor turns on at 40.7 and off at 37.7, yielding an average temperature of 39.2°F (4.0°C).
- Out2 is energized if the temperature falls below the heating set point and de-energized after it has been raised 3 degrees above that set point. It is factory set to 35.5°F.

To adjust those set points:

1. Press the SP (set point) button once to display the cooling set point. The out1 LED will light to indicate that set point can then be raised or lowered by 0.1°F by pressing the up or down arrowhead button (changes take effect immediately).
2. Press the SP button a second time to display the heating set point. The out2 LED will light to indicate that set point can then be adjusted using the arrowhead buttons.
3. Press the SP button a third time to display the current temperature and restore the normal operation of the Out1 and Out2 LEDs.

6.2.2: Refrigeration Module Removal

The refrigeration module is mounted in the stainless steel frame of the lower shell, resting on two rails that force it up against the bottom of the upper shell. Two hex-head bolts are inserted through the back end of each of those rails:

- The smaller, “positioning” bolt keeps the rear of the rail from moving to the side.
- The larger “elevation” bolt is used to raise or lower the back of the rail.

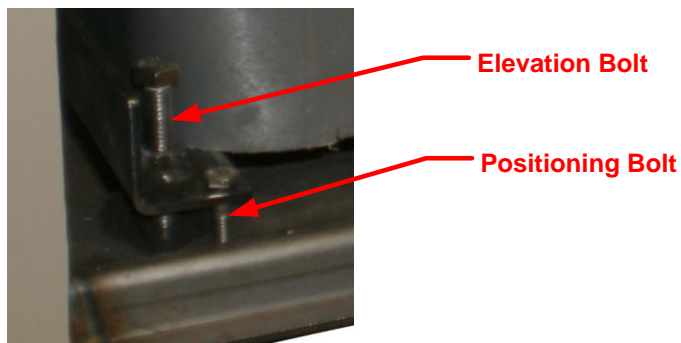

In addition, three upper rails (one in the front and one on each side) position the module so that its air flow ducts align with those of the upper shell, and a permanently-installed foam gasket seals those air passages between the upper and lower shell.

Use the following procedure to remove the module from the sampler:

1. Remove the four screws securing the sampler’s lower-rear access panel, then set them and that panel aside.
2. Remove the positioning bolt from each rail.
3. Lower the backs of the rails (and thus the refrigeration module) by turning the elevation bolts counter-clockwise, until the module is resting on the third, center rail.
4. Move the back ends of the side rails aside, so the module can be slid out past the elevation bolts.
5. Slide the module out of the sampler and unplug it.



6.2.3: Refrigeration Module Installation

Use the following procedure to install a new or repaired refrigeration module:

1. With the rails moved to the side, position the module on the center rail and push it as far into the cabinet as it will go—the upper rails will position it automatically.
2. Rotate the back ends of the side rails in and under the module.
3. Raise those rails and the module by turning the elevation bolts clockwise, until the foam gasket is slightly compressed.
4. Lock those rails in place by reinstalling the positioning bolts.
5. Position the access panel over the opening in the back of the lower shell and fasten it into place.

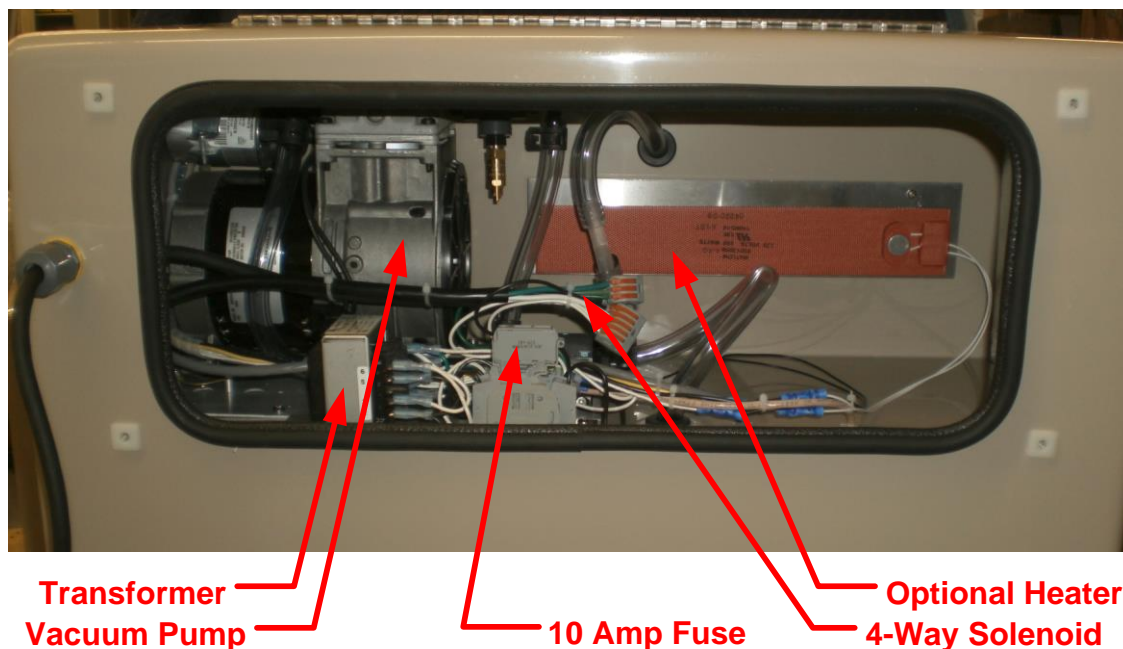

Figure 6-3: Optima Sampler Pump Compartment

6.3: Compression/Vacuum Pump

Each sampling system is equipped with one of two available continuous-duty, permanently-lubricated, piston air compressor/vacuum pumps that provide long-term consistent sampling with vertical lifts of up to either 23 or 28 feet. ***These pumps need no routine maintenance.*** In particular, and unlike the inconsistent, unreliable and costly to maintain peristaltic pumps used in competing samplers, they do not have flexible internal tubes that frequently wear out and need to be replaced.

The pump and its 4-way solenoid valve are mounted on a metal plate behind the sampler's upper rear access panel (as shown above). If your pump's performance declines unacceptably, replacement pumps and service/rebuild kits (including instructions) can be obtained from QCEC.

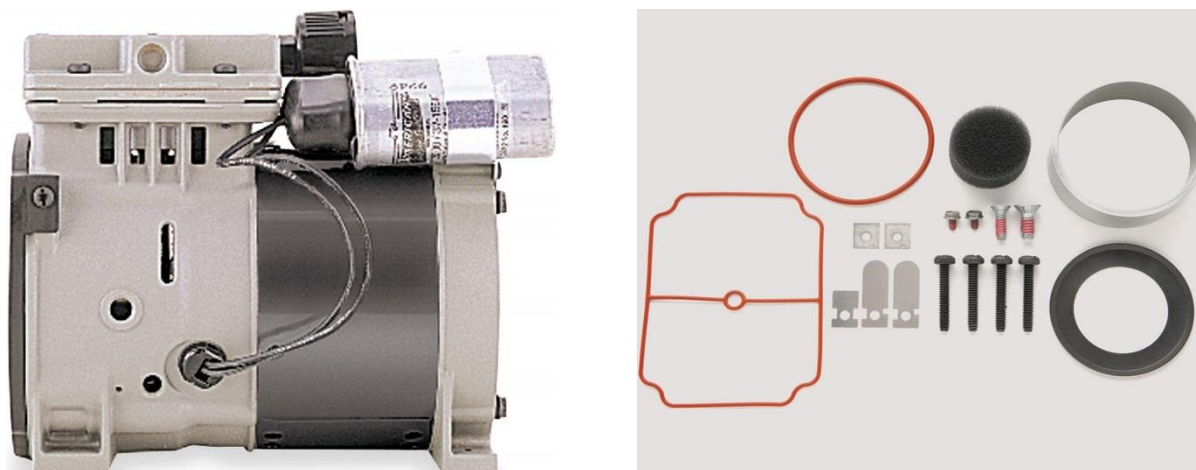

Figure 6-4: Quick-Lift Compressor/Vacuum Pump and Service Kit

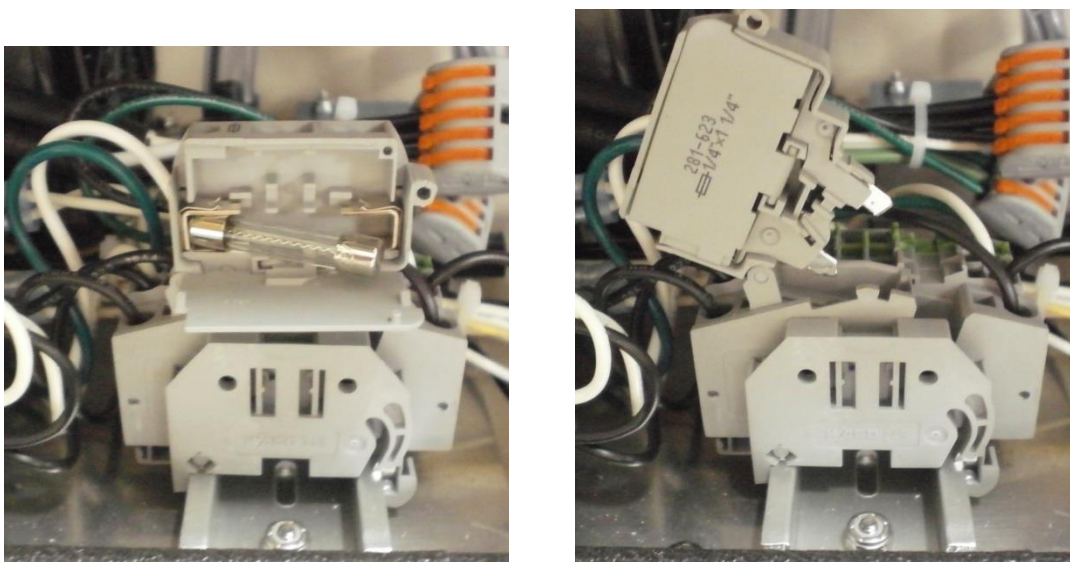

Figure 6-5: Control system fuse holder in open and tripped positions

6.4: Control System Fuse

The control system operates on 12 Vac power supplied by a transformer located in the vacuum pump compartment. Those components are protected by a fast-acting, 10A/250 V cartridge fuse whose enclosed holder is mounted next to the transformer.

As shown above:

- That fuse can be checked and/or replaced by pulling the front cover of that holder forward and down, which automatically ejects the right end of the fuse.
- The control system can be powered down by tipping the top of the holder up and to the left.

6.5: Optional 240-120 VAC Transformer

All-Season Samplers designed to run on 240 VAC power can be equipped with either a 240V refrigeration module, or a 120V module powered by a 240-120 VAC transformer mounted on the right side of the pump compartment. In the latter case:

- A hard-wired 120 VAC connection runs from that transformer up to the fuse in the pump compartment.
- The refrigeration module plugs into a receptacle mounted below that transformer.

6.6: Troubleshooting Tips

Use the following suggestions to troubleshoot the listed problems.

1: User interface panel is dark:

- a) Press any key to turn backlight on (it turns off after two minutes of inactivity).
- b) If the screen is still dark but you can make out that it is displaying information, use the Administration Menu to adjust the backlight (see page 30).
- c) If the screen is uniformly black, make sure the sampler is powered up (you should be able to hear the fan circulating air through the sample compartment).
- d) Check the control system fuse (see page 82)
- e) Reboot the controller by briefly tripping that fuse or unplugging the sampler.
- f) If the controller is powered but its interface panel is black, the logic board is probably defective—call QCEC for technical assistance.

2: One or more buttons never work:

- a) The logic board is malfunctioning—call QCEC for technical assistance.

3: Readout never changes and cannot be scrolled:

- a) Reboot the controller by briefly unplugging the sampler.
- b) Controller hardware or software is faulty—call QCEC for technical assistance.

4: Readout indicates program will automatically start at midnight, 12/31/99

- a) Stop the selected program and disable its Automatic Rerun parameter (see page 53).

5: Readout indicates an indexing error

- a) Reset and restart the sampling program—a broken arrow icon should appear on the display while the carousel rotates the first bottle into position.
- b) If that icon is displayed but the carousel does not turn:
 - i) Make sure the carousel is properly installed and free from obstructions.
 - ii) Make sure all 24 turntable magnets are in place.
 - iii) Check the turntable wiring.

6: Purging does not clear the intake line:

- a) Make sure the pinch valve is energizing and seals the discharge tube when it does.
- b) Check the intake strainer and tubing for obstructions.
- c) Make sure the vacuum pump and solenoid are pressurizing the sample chamber.

7: Samples are too large:

- a) Postpurge should lower the water level in the sample chamber to the bottom of its intake tube. If it doesn't:
 - i) Increase the Postpurge setting (see page 36).
 - ii) Make sure the vacuum pump and solenoid are pressurizing the sample chamber.
 - iii) Check the intake strainer and tubing for obstructions.
- b) Lower the sample chamber intake tube (see page 21).

8: Samples are too small:

- a) The sample chamber should fill to the bottom of the liquid-sensor electrodes. If not:
 - i) Increase the Sample Time setting (see page 36).
 - ii) Check the intake strainer and tubing for obstructions and make sure the intake strainer is fully submerged.
 - iii) Make sure the intake line is properly connected to the sampler's intake port. If a compression fitting is used, the ferrule must be properly positioned and the nut properly tightened.
 - iv) Make sure the pinch valve is energizing and seals the discharge tube when it does.
 - v) Make sure the vacuum pump and solenoid are depressurizing the sample chamber.
 - vi) Check for vacuum line leaks.
 - vii) Adjust the velocity control valve for more vacuum.
- b) If water does rise above the bottom of the intake tube, raise that tube (see page 21).

9: Sample is violently expelled from chamber without first purging intake line:

- a) Increase sampling time to assure liquid rises to contact both level-sensing electrodes.

10: Sampling continues despite full or over-flowing container(s):

- a) Composite samplers are equipped with a full-bottle float switch. When the bottle is full, the float icon should point down and the interval timers should remain at zero. If not:
 - i) Verify that the Float Option is enabled (see page 55).
 - ii) Verify that the float is properly installed.
 - iii) Check the float switch and its wiring.
- b) Sequential samplers must be properly configured to avoid overfilling their bottles:
 - i) Verify that the Bottle Limit feature is enabled. If you deliberately disabled it, be sure to replace the carousel before the bottles overflow.
 - ii) Verify that samples of the intended size are being drawn (see item 6 above)
 - iii) Make sure the Samples/Bottle setting (see page 50) multiplied by the actual sample size does not exceed 90 percent of the container (or bottle) volume.

11: Sample compartment temperature is too high or low:

- a) Verify that the refrigeration module and its optional heating element are cycling.
- b) Verify that the displayed temperatures are correct.
- c) Check the temperature of the air being returned to the compartment to make sure the refrigeration module is cooling.
- d) Adjust the thermostat set points.

12: Refrigeration Module fills with ice:

- a) Keep sample compartment door and control panel hatch latched shut at all times.

Appendix A: Controller Capabilities

This appendix describes the capabilities of the version 2.0 sample control system firmware, in order to help you decide how best to adapt it to the needs of your sampling application.

A.1: Overview

The control system consists primarily of six **sampling programs** and a **supervisory routine** that executes when the sampler is first powered up and whenever the selected program is stopped.

A.1.1: Supervisory Routine (Ready State)

When the sampler is powered up, the supervisory routine briefly displays the installed firmware version number and revision letter (e.g., Version 2.0 Revision C). It then indicates the controller is Ready to run. While it is operating in that state, the user interface panel can be used to:

- start the selected program immediately,
- start that program, but delay its execution to a specified future date and time-of-day, or
- display its administration and configuration menus, in order to:
 - set the sampler's configuration password and ID number, adjust its real-time clock and display panel, and manage its archival data;
 - select and configure the control program; and
 - set up certain hardware and menu system features (QCEC personnel only).

Once the selected program has been started, the menu system functions are unavailable until it stops (or is stopped)—at which time the controller returns to its supervisory/Ready state.

- ✎ The controller administration and program configuration functions are not available while the sampling program is running.

- if Flow/Bottle:
 - Flow Type (4-20mA|0-5V|0-10V|Pulses)
 - if 4-20mA|0-5V|0-10V:
 - Maximum Gallons [Liters] Per Minute
 - Sample Gallons [Liters] list
 - if Pulses:
 - Sample Pulses list
- Bottle Options group
 - Sample Type (Composite|Discrete)
 - if Composite:
 - Composite Size (options enabled at factory)
 - Samples per Bottle
 - if Discrete:
 - Bottle Configuration (options enabled at factory)
 - Number of Bottles
 - Samples per Bottle
 - Index Type (AfterBottle|AfterSample|AfterTime|RealTime)
 - if After Time:
 - Index Minutes
 - if Real Time:
 - Index Time (of day)
 - Index Minutes
- Program Run Options group
 - Automatic Rerun
 - Delay Start (minutes)
 - Float Input Option (enable/disable)
 - Fault Output Option (enable/disable)
 - Timed Stop (None|24Hour|12Hour|8Hour|Custom)
 - if Custom:
 - Stop Time (minutes)
- Program Events list
 - for each:
 - Program Event (Start|Stop|Sample|Pause|Halt|Resume)
 - Weekdays
 - Time (of day)
- Administration Menu
 - Set Password
 - Clear Password
 - Set Daylight Savings Time
 - Set Clock
 - Adjust LCD
 - Download Archive
 - Clear Archive
 - Set ID
 - Set Units (English|Metric)
- Loadcell Menu (for QCEC personnel only, not applicable to CVE samplers)
- Factory Menu (for QCEC personnel only)

A.2: Inputs and Outputs

As shown on the Electrical Diagram appended to this manual, the sampling controller has the following required and optional inputs and outputs:

- run-status and alarm output relays (see below)
- a turntable motor control output and two position sensor inputs (see below)
- a sample-compartment temperature input (see page 89)
- one analog and one discrete-pulse flow input (see page 89)
- a float-switch input (see page 90)
- a sample-chamber liquid sensor (see page 91)
- pump-motor, solenoid-valve and pinch-valve outputs (see page 91)

A.2.1: Run-Status Output

The controller energizes the power board's run-status relay (thus connecting pins 3 and 4 of the optional field I/O connector) as each sampling cycle is initiated, and de-energizes it as that cycle discharges the sample it collected.

A.2.2: Alarm Output

If the power board's alarm relay is enabled (see page 54), the controller energizes it (thus connecting pins 5 and 6 of the optional field I/O connector) when:

- the sampling program is waiting to be reset after completing normally, being manually stopped, or failing to determine the position of the sequential-sampling turntable;
- sampling has been suspended because the float input circuit is open, as discussed below (this will also be indicated by displaying a fault icon along the right edge of the screen);
- the most recent sample cycle failed to trigger the liquid sensor, potentially indicating that sample was smaller than intended; or
- the storage compartment has been above its intended temperature for at least 30 minutes (this will also be indicated by displaying a °C icon along the right edge of the screen).

A.2.3: Turntable I/O

The controller uses one discrete output and two discrete inputs to operate the optional sequential-sampling turntable.

- That output starts and stops the turntable's motor by energizing and de-energizing the power board's table control relay.
- Those inputs are wired to sensors that detect the passage of magnets (usually 24) that are radially embedded in the turntable's upper plate. The H sensor is positioned to detect the turntable's single home-position magnet, while the S sensor detects the others.

All three circuits are wired to a seven-pin CPC mounted in the roof of the sample compartment.

⚠ Because the turntable uses a direct-current motor, its rotation can be reversed by swapping the wires connected to pins 1 and 2 of the turntable CPC.

A.2.4: Temperature Input

All-Season Samplers are equipped with resistive temperature devices (RTDs) that their controllers use to measure their sample compartment temperatures. Each RTD is mounted to the return air duct in the back of that compartment, and connected directly to the logic board's temperature input port.

A.2.5: Flow Inputs

The controller provides one analog and one discrete input that are meant for connecting flow meter signals. All All-Season Samplers are equipped with four-pin circular plastic connectors (CPC) that provide terminals for both of those inputs.

Connecting either type of signal allows you to configure flow interval counters (see page 94) that will initiate samples as the total flow in the sampled stream passes specified volumes. Or, the pulse input can be used to remotely trigger the collection of individual samples (see below):

To do that, you must set parameter(s) that specify the connected signal type (4-20 mA, 0-5 VDC, 0-10 VDC, or discrete pulse):

- If an analog flow-rate signal is connected, you must also specify the flow rate (in gallons) corresponding to its maximum value (20 mA, 5 VDC or 10 VDC) and the desired flow intervals in gallons. The controller then integrates that signal to determine the accumulated flow, and draws samples at the specified intervals.

✎ *Multiple devices can be connected in series to a 4-to-20 mA transmitter, provided they do not share a common ground and their summed resistances don't exceed the transmitter's capacity. The internal resistance of our sampler's current-loop input is 250 ohms.*

- The discrete signal type is intended to be used with a flow meter that integrates its own flow rate measurement and pulses an output relay on and off at specific accumulated flow intervals. If you connect such an input signal, you need only specify the number of pulses corresponding to the flow intervals at which samples are to be drawn.

Assuming you really want your samples to be drawn at flow volume intervals, you can calculate those counts by dividing the desired flow intervals (in volumetric units) by the incremental flow (in the same units) that triggers each meter relay pulse.

For example, assume the meter pulses its output relay once for every 1000 gallons of stream flow, and you want to sample that stream at 25,000 gallon intervals. You should then set the interval duration to 25 pulses per sample (25000 gallons per sample divided by 1000 gallons per pulse).

A.2.5.1: Remote Sample Initiation

Alternately, you can repurpose the pulse input to initiate a sample each time its circuit is closed by a connected PLC or other external device, effectively allowing such a device to remotely trigger the collection of individual samples.:

1. Select either the Flow or Time+Flow sampling interval option.
2. Set the Flow Type parameter to Pulses.
3. Set the Flow Option parameter to Pulses Fixed.
4. Set the Sample Pulses parameter to 1.

A.2.6: Float Input

The controller provides one internally-powered discrete input that can be connected to an internal bottle-full and/or an external stream-level float switch. The controller can then be configured (see below) to draw samples only while or after that input circuit has closed. Thus:

- If a bottle-full float switch is connected (composite samplers only), it should open as the fluid level rises above about 90 percent of the container's volume. The sampler could then be configured to stop drawing samples when the bottle filled up.
- If a stream-level float switch is connected, it should close as the stream level rises above an appropriate minimum level. The sampler could then be configured to draw samples only when the stream depth was sufficient to cover the intake strainer (or above some other appropriate threshold).

✎ More generally, you could configure this input for either run- or start-permissive operation and connect it to any appropriate PLC or other field device relay.

All CVE samplers are equipped with an internal CPC that has two bottle-full float-switch pins. In addition, each can optionally be equipped with a field I/O connector whose two stream-level float-switch pins are connected in series with the bottle-full pins provided by the internal CPC. If both connectors are present, you can:

- connect only a bottle-full float switch. You will then need to install a jumper across the float-switch pins of the field I/O connector so the bottle-full switch will close the input circuit unless the bottle is full.
- connect only a stream-level float switch. You will then need to install a jumper across the float-switch pins of the internal connector so the stream-level switch can close the input circuit when the stream flow is high enough to sample.
- connect both a bottle-full and a stream-level float switch. The input circuit will then open if either switch does (i.e., if the sample bottle fills up or the stream flow falls too low).

✎ When converting a composite sampler with both float switches into a sequential sampler, replace the bottle-full float with a cable that wires pins 2 and 3 of its connector together.

A.2.6.1: Factory Menu Float Setting

If the Float Option (see page 55) is enabled and its input circuit is open when the control program is started, the unit will not start drawing samples until all connected float switches are closed. If that circuit opens after sampling has begun, the program's response will depend on its Factory Menu FLT setting (which is set to your specifications before the unit is shipped):

- If the FLT START/STOP setting is selected, the program will reset its sampling interval counters and not restart them until the float circuit closes again (i.e., those counters will restart from zero when an empty sample container is installed or the water level rises high enough to reclose the stream-level float switch).
- If the FLT START setting is selected, the program will continue sampling even while that circuit is opens. This option must not be used with a bottle-full float switch!

If the FLT OFF setting is selected, the float input is disabled and the Program Menu's FLOAT INPUT parameter is hidden.

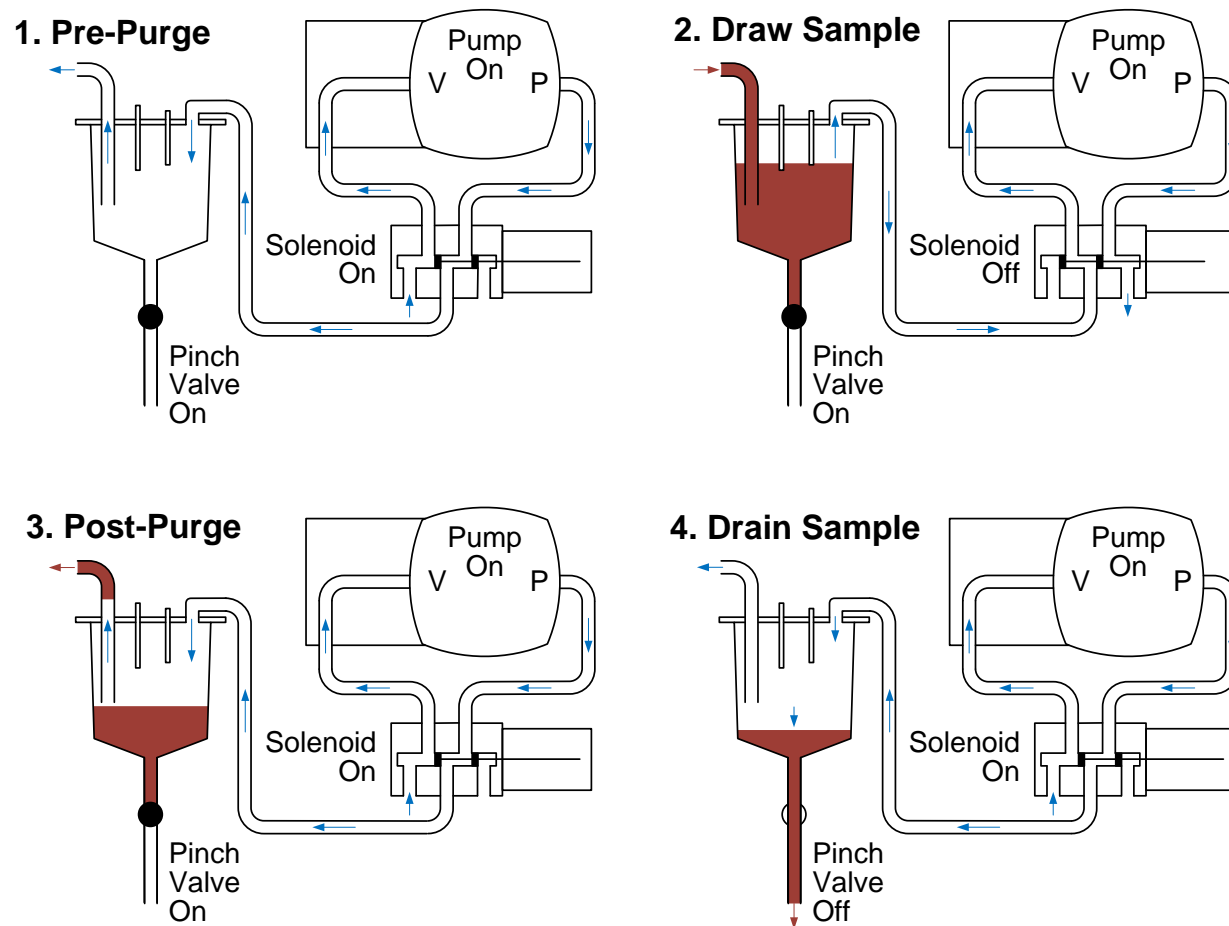

Figure A-1: CVE-16 Sample Chamber Pressure Sequencing

A.2.7: Liquid Sensor

Each sample cycle vacuums wastewater into the sample chamber until it rises high enough to conduct an electric current between two electrodes that project down from the chamber lid (see panel 2 in the above illustration). The liquid sensor that charges those electrodes and detects the resulting current attaches to the controller's SDI-12 communication port.

A.2.8: Sampling Outputs

Three electrically-actuated devices control the flow of air and wastewater into and out of the sample chamber (as illustrated above). As shown on the appended Electrical Diagram, each of those devices is controlled by a relay on the controller's power board:

- The Pump relay turns the compressor/vacuum pump motor on at the beginning of each sampling cycle, and off after the collected sample has been discharged.
- The Solenoid relay energizes and de-energizes the four-way solenoid valve that alternately connects the sample chamber to that pump's the vacuum or pressure port.
- The Pinch relay energizes the pinch valve solenoid to seal off the chamber's discharge tube during all but the final (discharge) phase of the sampling cycle. That valve connects to it via a 2-pin CPC in the roof of the sample compartment.

A.3: Sampling Program

The sampling programs all use the same underlying instructions, but can be configured (via the Program Menu) to provide very different feature sets. Each can be set up to:

- draw samples (or sets of consecutive samples), at specified time or flow intervals;
- rinse the sampling line up to four times prior to drawing each sample;
- repeat any sampling cycle up to four times (five total) if needed to collect the desired volume of wastewater;
- discharge each sample into a specified bottle (sequential samplers only), keeping track of the number of samples discharged to each;
- delay its execution a specified number of minutes after it is started, or until the optional float input is asserted (or pause and resume repeatedly as that input is set and cleared);
- automatically stop after a configurable amount of time or number of samples; and
- start sampling, pause or halt and later resume, take manual samples and finally stop at scheduled times on specified days of the week, then automatically restart itself if desired.

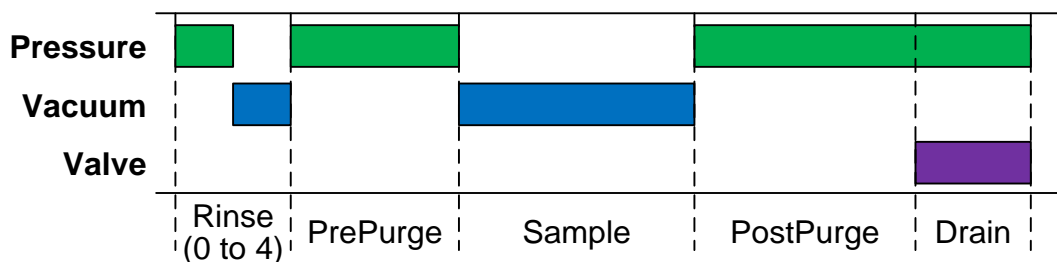

Figure A-2: CVE Sampling Cycle

A.3.1: CVE-16 Sampling Cycle

The figure above illustrates the full CVE sampling cycle, which can be configured to include up to four optional **rinse** cycles (one is shown) and an optional **prepurge** step (also shown). Figure A-1 on page 91 illustrates the corresponding air flows:

1. The sampling tube and strainer are optionally rinsed up to four times and then “prepurged” to clear out accumulated water and debris:
 - The prepurge pressurizes the sample chamber for a specified number of seconds, which will presumably clear the intake line. It is rarely disabled.
 - It can be preceded by up to four rinses, each of which first pressurizes the chamber to blow out the line and then sucks a limited amount of water into it. The prepurge phase would then blow out the water drawn in by the last rinse.

⚠ *If you enable one or more rinse phases, use the manual sampling feature to make sure your settings do not draw water into the sampling chamber.*

2. The chamber is depressurized to draw wastewater into the chamber until it is high enough to conduct an electric current between the liquid-sensor electrodes, which project down from the chamber lid.

⚠ *Your Sampling Time setting should be just long enough to raise the wastewater up to the liquid-sensor electrodes, as an added precaution against drawing water into the pump.*

If the liquid sensor is not tripped within the configured time (Sample Seconds):

- If the Fault Option is enabled, an alarm will be indicated.
 - If the Sample Recycling feature is enabled, the rinse, prepurge and vacuum steps will be repeated (see below).
3. The chamber is “postpurged” for a specified number of seconds to expel the excess water and clear the entire sample intake tube.
 4. The sample is drained by opening the discharge valve for 12 seconds while continuing to pressurize the chamber.
⚠ Make sure your PostPurge setting is long enough to completely clear the inlet tube before the discharge valve opens, so the chamber pressure will not be so high as to spray the sample into the storage container.
 5. If duplicate sampling has been set up (see page 98), this procedure immediately repeats the specified number of times.
⚠ Sequential samplers can be set to discharge consecutive samples into the same or consecutive bottles, depending on whether you want to collect duplicate or larger samples.
 6. If the unit is equipped with a sequential-sampling carousel, it is rotated (if needed) to position the next sample’s intended bottle beneath the discharge tube.

A.3.1.1: Sample Recycling

Enabling the Recycling feature causes each sample cycle to repeat its rinse, prepurge and sample extraction phases up to a specified number of times (at most four) before discharging the accumulated sample. until the liquid sensor detects wastewater within the configured Sample Seconds:

If the sample was underweight because debris was sucked into and restricted the intake tube, the repeated pre- and post-purging might clear the obstruction and allow the sample to reach its intended weight/volume. If it was underweight because the sampler was sucking air due to an insufficient sampled stream flow, that flow might increase during the recycling process.

In any event, if the final, discharged sample is underweight, a non-fatal fault is indicated and the program keeps running. The fault is cleared the next time a full sample is collected.

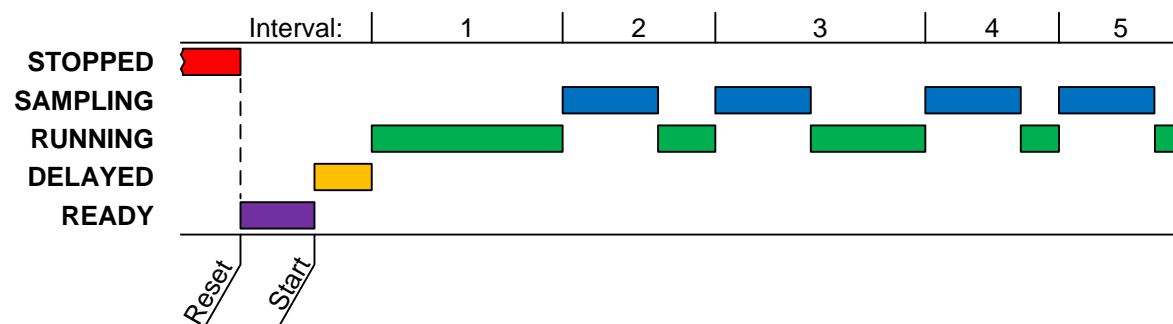

Figure A-3: Basic Sample Timing Diagram

A.3.2: Sampling Intervals

Each program is configured to draw samples in an optionally repeating sequence of up to 24 fixed or variable, time and/or flow-based Sampling Intervals. As shown above, the first interval starts after any configured delay (see page 99). At the end of that interval, the program simultaneously triggers its first automatic sample and restarts its interval counter(s). And so on.

The durations of time-sampling intervals are specified in minutes. If any flow-sampling options is selected, a suitable flowmeter must be connected (see page 89) and the interval durations are specified in gallons or flow input pulses (each corresponding to a fixed increment in the total flow measured by the meter):

- When **Time** sampling is chosen, the interval lengths (in minutes) can be fixed or vary in a specified sequence.
- When **Flow** sampling is chosen the interval lengths (in gallons or pulses) can be fixed or vary in a specified sequence,.
- When **Time+Flow** intervals are chosen, both a maximum time and a maximum accumulated flow interval are specified for each sample. Fixed or variable lengths can be independently set for each. For example, you could specify a sequence of variable flow intervals with a fixed maximum time between samples. When the first of each sample's intervals elapses, its sampling cycle is initiated and both interval counters are restarted.
- When **Time/Bottle** (or **Flow/Bottle**) sampling is chosen, the sampling interval durations can be independently specified for each sequential-sampling bottle (see page 98).

A.3.2.1: Variable Intervals

Selecting Time Variable (or Flow Variable) interval timing allows you to specify a sequence of up to 24 interval durations.

- Each sample is drawn when the corresponding interval elapses, until the program's stopping criterion is met (see page 99).
- If the specified number of intervals is fewer than the number of samples the program is configured to draw, the last of those intervals will be used for all subsequent samples.

For example, if the program is configured to stop after 750 minutes (12.5 hours), and you configure six alternating 2 and 1 hour intervals (i.e., 2, 1, 2, 1, 2 and 1), the sixth interval would be used for the sixth and all subsequent samples. Thus, samples would be drawn after 2, 3, 5, 6, 8, 9, 10, 11 and 12 hours.

A.3.3: Bottle Options

Each program must be “told” how many sample containers it is to use, how big they are, and how many samples it is to put into each container. This is done by configuring the installed

Sampling Type and then setting the associated **Bottle Options** parameters:

- If a single-container, composite-sampling system is installed, the Composite sampling type must be selected—if you are even given a choice.
- If a multiple-bottle, sequential-sampling system is installed, the Discrete sampling type must be selected.

✎ Each sampler is usually sold with only a Composite or Sequential sample storage system (see page 16). If so, its programs are factory configured to use that Sample Type and the Program Menu is set to keep you from changing it. That menu is also factory set to let you select from only the container sizes or bottle carousels you have purchased.

One option you must always set is how many samples are to be discharged into each bottle—which obviously should be less than the number needed to fill it. To derive an appropriate upper limit for that setting:

1. Adjust the sample chamber’s intake tube to obtain the desired sample size (see page 21).
2. Divide the measured volume of such a sample into your container size, multiply by 0.9, and round down to the next lowest integer.

✎ The maximum number of samples you can specify for each bottle is limited to 90 percent of the selected bottle size divided by an arbitrary 20 ml minimum sample size. Assuming your sample size is larger than that, the actual maximum number of samples per bottle will be proportionately lower.

✎ Any time you adjust the sample size, you should collect a manual sample and measure its volume. Then make sure the specified Samples per Bottle will fit into the installed bottle(s).

✎ At least one extra container or carousel and set of bottles is usually kept on hand to allow sampling to continue while the filled bottles are readied for reuse.

A.3.3.1: Composite Sampling

If a single-container, composite-sampling system is installed, the Composite sampling type must be selected. You then specify the size of that bottle and the Number of Samples to be automatically collected and discharged to it:

- The Composite Size setting specifies the size of the sample container.
- The Samples per Bottle setting specifies how many samples will be discharged to that container before the program automatically stops. The bottle-full float switch will stop the interval timer(s) when the container is approximately 90 percent full even if the specified number of samples per bottle have not been collected.

A.3.3.2: Sequential Sampling

If your sampler is equipped for sequential sampling, you must select the Discrete sampling type, specify which bottle carousel is installed, and define the criteria for indexing (i.e. distributing) samples among that carousel's bottles:

- The Bottle Configuration setting specifies the number and size of the bottles in the carousel (for example, 24 1000 specifies a carousel housing 24 1000 milliliter bottles).
- The Number of Bottles setting specifies how many of the available bottles will be used.

Each program will always discharge its first sample into the bottle in the first carousel position. If Number of Bottles is less than the number actually in the carousel, the difference dictates how many will not receive any samples.

- The Samples per Bottle setting specifies how many samples will be discharged to each bottle before the program automatically stops.

Unlike the composite-sample containers, sequential-sampling bottles cannot be equipped with float switches to prevent them from being overfilled (because the wiring for such switches would wind up as the carousel rotates). It is the responsibility of the user to make sure his/her sampling program(s) will not overfill those bottles!

- The Index Type setting specifies when the next bottle will rotate into position.

Each program will always discharge its first sample into the bottle in the first carousel position. If Number of Bottles is less than the number actually in the carousel, the difference dictates how many will not receive any samples.

A.3.3.2.1: After-Bottle Indexing

After-Bottle indexing rotates the carousel after each bottle has received the specified number of Samples per Bottle. Thus, the carousel will rotate at most one full turn.

For example, assume a 24-bottle carousel is set for After Bottle indexing, Number of Bottles is set to 20, and Samples per Bottle is set to 5. The program would then collect a total of 100 samples, discharging the first 5 to the position 1 bottle, the next five to the position 2 bottle, and so on until samples 96 through 100 were discharged to the position 20 bottle, after which the program would stop. Four bottles would remain empty.

A.3.3.2.2: After-Sample Indexing

After-Sample indexing rotates the carousel each time a sample is discharged, until each of the specified Number of Bottles has received the specified Samples per Bottle. The carousel will thus rotate Samples per Bottle full revolutions. Any manually-drawn samples would count toward the Samples per Bottle limits of the bottles they were discharged to.

For example, assume a 24-bottle carousel is set for After Sample indexing, Number of Bottles is set to 20, and Samples per Bottle is set to 5. The program would then collect a total of 100 samples, rotating the carousel 5 full turns. The first sample would be discharged to the bottle in position 1, the second to the bottle in position 2, and so on until sample 20 was discharged to the bottle in position 20. Bottle 1 would then be rotated into position to receive sample 21, skipping the last four bottles. Sample 22 would be discharged to bottle 2, and so on until the 40th sample was discharged to bottle 20. This would repeat until sample 100 was discharged to bottle 20. The program would then stop, with 5 samples in each of the first 20 bottles.

A.3.3.2.3: After-Time Indexing

After-Time indexing type rotates the carousel in regular, timed steps whose duration is specified by the Index Minutes parameter. The first indexing interval begins when the sampling interval counters are initiated.

At the end of the first indexing interval, the second bottle is rotated into position and the sampling interval counters are reset. The second bottle is then serviced for Index Minutes, after which the third is rotated into position and the sampling intervals are again restarted. This continues until the specified Number of Bottles have been serviced.

An additional run-time screen is provided which displays the duration of the indexing interval and counts up to the next turntable rotation.

If any bottle receives the specified maximum Samples per Bottle before its indexing interval elapses, no further samples will be drawn until the next bottle is rotated into position.

A.3.3.2.4: Real-Time Indexing

Real-Time indexing is the same as After-Time indexing, except that it rotates the second bottle into position at a specified Index Time (of day).

Ideally, the program would be started (or set to automatically start) Index Minutes prior to the specified Index Time, so the first and each subsequent bottle would be used for Index Minutes. For example, if Index Minutes is set to 1440 (24 hours) and Index Time is set to midnight on January 2, sampling would ideally be started at midnight on January 1. The indexing counter would then immediately start at 0 and count up to Index Minutes:

- If the program is started more than Index Minutes before the specified Index Time, the displayed indexing counter will not start until the time remaining until Index Time is equal to Index Minutes.
- If the program is started less than Index Minutes before Index Time, that counter starts with an initial value greater than zero (essentially Index Time minus Index Minutes).

Real-Time indexing is the same as After-Time indexing, except that it rotates the second bottle into position at a specified Index Time (of day). The displayed indexing interval counter does not start until Index Minutes prior to the specified Index Time.

A.3.3.3: Per Bottle Sampling

If your sampler is equipped for sequential sampling, its programs can progress through a sequence of sampling intervals as each bottle is rotated into position:

- To set a different time sampling interval for each bottle, set the Sample Interval parameter to Time/Bottle. Then define the interval for each bottle by setting the corresponding element in the Bottle Minutes list.
- To set a different flow sampling interval for each bottle, set the Sample Interval parameter to Flow/Bottle. Then define the interval for each bottle by setting the corresponding element in the Bottle Gallons or Bottle Pulses list.

You can set up to 24 such intervals (one for each bottle in a 24x500 or 24x1000 carousel), but might not need to:

- The Number of Bottles value you entered (see page 96) is the maximum number of intervals you might need to set.
- If you define a lesser number of intervals, the last one you do set will be used for all subsequent bottles.

For example, if the program is configured to use six bottles, and you set a total of four alternating 2 and 1 hour intervals (i.e., 2, 1, 2, 1), that fourth interval would be used for the last three bottles:

- Samples discharged to the first bottle would be drawn at 2-hour intervals.
- Samples discharged to the second bottle would be drawn at 1-hour intervals.
- Those discharged to the third bottle would again be drawn at 2-hour intervals.
- All remaining samples would be drawn at 1-hour intervals (bottles 4, 5 and 6).

A.3.3.4: Duplicate Sampling

If your sampler is equipped for sequential sampling, its programs can be configured to save samples to multiple bottles at essentially the same time by:

- assigning the Cycle group's Consecutive Samples parameter a value greater than one, and
- setting the Bottle Options group's Index Type parameter to After Sample.

For example, assume a 24-bottle carousel is set for After Sample indexing, Number of Bottles set to 24, Samples per Bottle set to 1 and Consecutive Samples is set to 3. Each time the interval counter elapsed, three samples would be drawn as quickly as possible and discharged to the next three empty bottles.

Assuming no manual samples were drawn, the first three samples would be drawn in quick succession and discharged to bottles 1, 2 and 3. The second three would be discharged to bottles 4, 5 and 6, and so on until the sixth set of three samples were drawn and discharged to bottles 22, 23 and 24. The program would then stop.

If a manual sample was drawn after the second set of three automatic samples, it would be discharged to bottle 7 and the third set of samples would be discharged to bottles 8, 9 and 10. Assuming no more manual samples, the fifth set of automatic samples would go into bottles 20, 21 and 22. The sixth set could only discharge 2 samples—to bottles 23 and 24. The program would then stop.

A.3.4: Delayed Starting

The selected sampling program can be started by pressing either the START [F1] or TIMED [F2] key while the controller is in its Ready state (i.e., when the supervisory routine is running):

- Pressing START [F1] starts the program immediately.
- Pressing TIMED [F2] prompts you to specify the date and time at which the program will appear to start. Until then, it will operate in a Timed state in which the sampling interval counters do not run but you can initiate manual samples. An additional run-time screen will display the date and time at which the program will “start”, along with the current time and date. When that time comes, the program will proceed as if you had just pressed the RUN [F1] key.

If one or more Program Start events (see page 100) have been configured, the program will also enter its Timed state when the START [F1] key is pressed. It would then proceed as if you had just pressed the RUN [F1] key when the first scheduled start time arrived.

In either case, the sampling interval counters might be further delayed:

- If the program has been set to wait for a Float input (see page 90), it will not start its interval counter(s) until that input is asserted.
- If a non-zero value (up to 9999 minutes) has been assigned to the Delay Start run Option (see page 54), the first sampling interval will be further delayed by that many minutes (see Figure A-3 on page 94). Until then, the program will display its operating state as DELAYED.

A.3.5: Timed Stopping

Once a sampling program has started, it will continue running until it has drawn the number of samples specified by its Bottle Options unless:

- it is stopped by pressing the STOP [F3] key,
- its Timed Stop Run Option (see page 55) has been set to stop it a specified number of hours or minutes after the program was started, or
- Stop Program events have been configured it to stop at configured times on specified days of the week (see next section).

If either a Timed Stop or a Stop Program event has been configured, an additional run-time screen will show the scheduled stop time and all such screens will display a timer icon.

A.3.6: Scheduled Events

Each program can be set to automatically start its interval counters, pause or halt and then resume, initiate manual samples, or stop itself at scheduled times on specified days of the week. As discussed on page 57, those **Program Events** are defined by a variable-length list of parameters, each of which has three associated values:

- the type of event (see table on next page),
- the days of the week on which the event will be executed, and
- the time of day on those days at which the event will be initiated.

Events do not have to be defined in the order they will execute, and can only be added or deleted from the end of the list.

Table A-1: Available Program Event Types

| | |
|-----------------------|--|
| Start Program | The parent program will start automatically if it is ready when the scheduled time is reached on the next scheduled day. |
| Stop Program | The parent program will stop automatically if it is running when the scheduled time is reached on the next scheduled day. Unless the Auto Rerun option is enabled (see page 53), the program will have to be manually reset before it can be restarted. |
| Manual Sample | A manual sample will be drawn if the program is running when the scheduled time is reached on the next scheduled day. If a time or flow interval elapses while the manual sample is being drawn, an automatic sample will be drawn as soon as the manual sample cycle has been completed. |
| Pause Program | Sampling will be suspended if the program is running when the scheduled time is reached on the next scheduled day, but the time and flow interval counters will continue to run. Sampling can be resumed by a Resume Program event, or from the user interface panel. If one or more intervals elapse while the program is paused, only the first such sample will be drawn when the program is resumed. |
| Halt Program | The interval time and flow counters will be paused if the program is running when the scheduled time is reached on the next scheduled day. Those counters can be resumed (with the accumulated values they had at the time they were halted) by a Resume Program event, or from the user interface panel. |
| Resume Program | Interval sampling will resume if the program is paused or halted when the scheduled time is reached on the next scheduled day. |
| End List | Previous event is the last one on the list. Changing an event's type to End List deletes it and all high-numbered events. |

A.3.7: Data Archiving

Every sampler manufactured since mid-March of 2016 archives a timestamped record of:

- each time one of its six sampling programs was started and stopped;
- each sample it has collected, including which bottle it was deposited into and whether or not recycling was required to obtain the desired volume; and
- all operational exceptions, including:
 - power loss and restoration,
 - bottle-full sampling suspensions,
 - sequential turntable indexing errors, and
 - sample compartment temperature deviations.

These sample and exception records are separated into multiple log files. Each time a sampling program completes or is stopped, its log file is closed and a new one is opened. Exceptions that occur between sampling runs are thus logged into the following run's file. The controller will keep up to 50 such files, after which the oldest file will be deleted each time a new one is created. The newest file is accessed as log 1, the one recorded prior to log 1 is accessed as log 2, and so on.

Currently, those log files can only be:

- reviewed onscreen when the menu system is not in use (see page 74); and
- deleted using the Administration Menu's Clear Archive option (see page 31).

Future versions of the controller software will also provide ways to copy the log files to USB memory devices, or download them to connected computers or SCADA systems.

Appendix B: Replacement Parts

Table B-1: Electrical System Parts

| Part | Number | Additional Information |
|-------------------------------|--------|--------------------------------------|
| Power Cord, Standard, 9-foot | WW142 | North American 120VAC plug |
| Power Cord, EEC, 9-foot | WW447 | European 220VAC plug |
| AC Fuse | WW326 | fast-acting, 10A/250V cartridge fuse |
| Transformer, Controller Power | WW300 | step-down from 120 or 240VAC |

Table B-2: Temperature Control System Parts

| Part | Number | Additional Information |
|---|--|-----------------------------------|
| Pump Heater, 120 VAC | WW422 | 75W/120V element, with thermostat |
| Pump Heater, 240 VAC | WW438 | 75W/240V element, with thermostat |
| Refrigeration Module, 120 VAC Module Heater, 120 VAC Refrigeration Module, 115 VAC with Heater Compressor, 120 VAC Evaporator Fan, 120 VAC Condenser Fan, 120 VAC | WW670 WW422 WW671 RM3000 WW083 RM3008 | |
| Refrigeration Module, 240 VAC Module Heater, 240 VAC Refrigeration Module, 230 VAC with Heater Compressor, 240 VAC Evaporator Fan, 240 VAC Condenser Fan, 240 VAC | WW672 WW438 WW673 WW450 WW448 WW449 | |
| Thermostat, 120 VAC Thermostat, 240 VAC Temperature Sensor Mounting Box | WW411 WW451 WW412 WW414 | |

Table B-3: Sampling Control System Parts

| Part | Number | Additional Information |
|--------------------------------|--------|---------------------------|
| Controller, Complete | WW322 | specify sampler model |
| Controller Backup Battery | WW390 | CR2032 |
| Controller Face Plate | WW354 | |
| Controller Face Plate Gasket | WW355 | |
| Controller Logic Board | WW401 | specify controller model |
| Controller Power Board | WW320 | |
| Field I/O Connector | WW002 | 6-pin CPC panel connector |
| Protective Cover | WW005 | |
| Mating Cable Connector | WW001 | screw terminations |
| Flow Inputs Connector | WW024 | 4-pin CPC panel connector |
| Protective Cover | WW005 | |
| Mating Cable Connector | WW025 | screw terminations |
| Float Switch, Sample Container | WW130 | |
| Liquid Sensor Controller | WW456 | |
| Long Electrode | WW454 | |
| Short Electrode | WW455 | |
| Temperature Probe | WW405 | |
| Turntable Connector | WW171 | 6-pin CPC panel connector |
| Mating Cable Connector | WW172 | crimp-pin terminations |

Table B-4: Vacuum/Pressurization System Parts

| Part | Number | Additional Information |
|-------------------------------|--------|-----------------------------|
| Pressure Regulator, 20 psi | WW092 | |
| Solenoid Valve, 4-Way | WW030 | |
| 115V Vacuum Pump, Quick Lift | WW102 | 1/3 HP, 120 VAC piston pump |
| 230V Vacuum Pump, Quick Lift | WW439 | 230 VAC piston pump |
| Vacuum Pump Mounting Pads | WW131 | 4 required |
| Vacuum Pump Service Kit | WW298 | |
| Velocity-Limiter, Bleed Valve | WW033 | a.k.a. Pisco Valve |
| Velocity-Limiter, Check Valve | WW019 | |

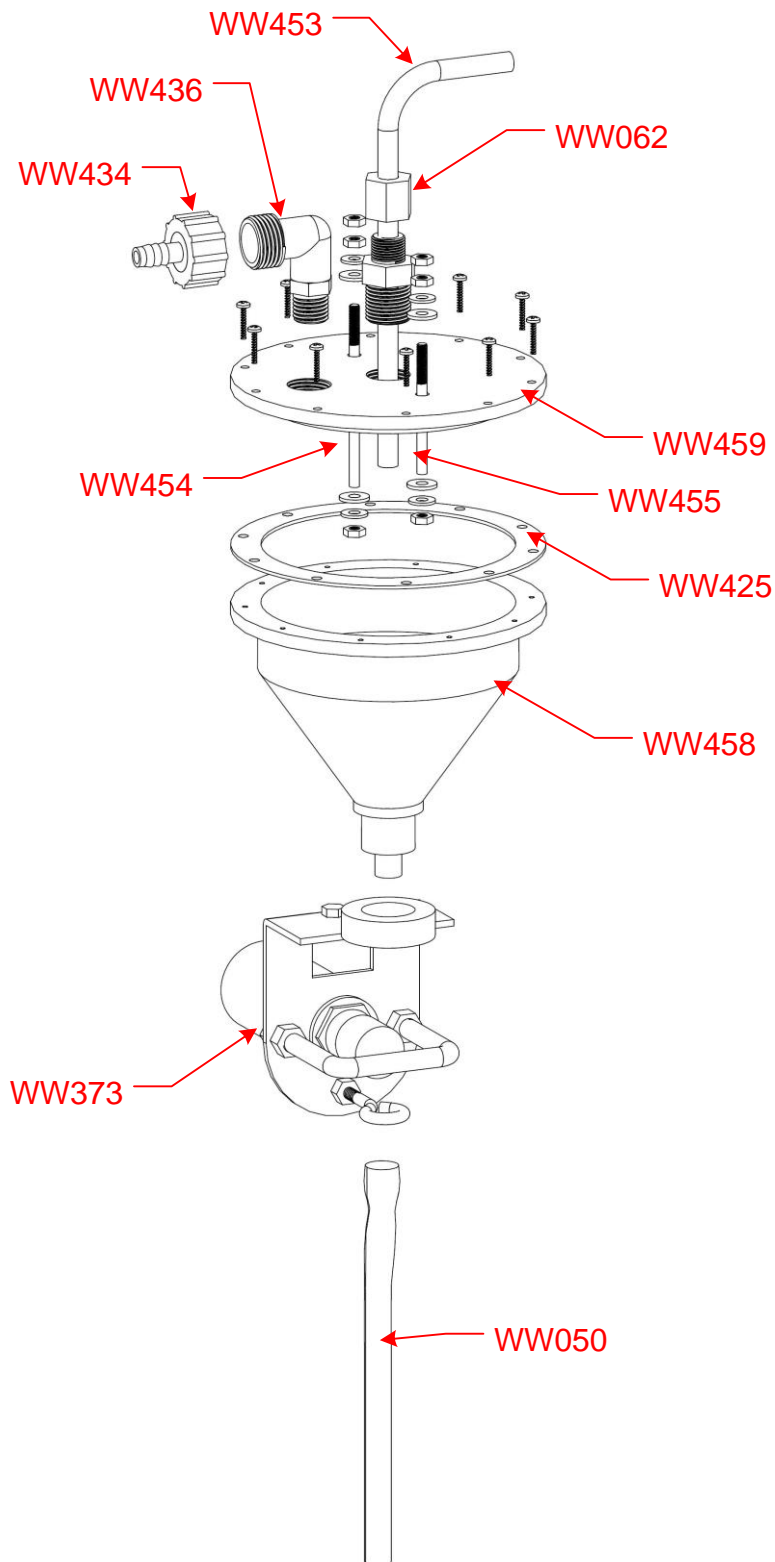

Figure B-1: CVE-16 Sample Chamber Parts

Table B-5: Intake Line Parts

| Part | Number | Additional Information |
|----------------------------------|--------|---------------------------------|
| Intake Fitting, Compression | WW112 | |
| Intake Strainer, PVC & Stainless | WW189 | |
| Intake Strainer, Stainless Steel | WW181 | |
| Intake Tubing, 3/8-inch I.D. | WW043 | sold by the foot—specify length |

Table B-6: Sample Chamber Parts

| Part | Number | Additional Information |
|------------------------|--------|--|
| Chamber Body | WW458 | includes discharge fitting specify CVE-16 lid |
| Chamber Lid | WW459 | |
| Chamber Gasket | WW425 | |
| Discharge Hose | WW050 | cut to length after installing |
| Intake Fitting | WW062 | |
| Intake Tube | WW453 | |
| Long Electrode | WW454 | for liquid sensor |
| Short Electrode | WW455 | |
| Pinch Valve Assembly | WW373 | |
| Solenoid | WW193 | |
| Solenoid Cover | WW370 | |
| Vacuum Fitting, Nipple | WW434 | |
| Vacuum Fitting, Elbow | WW436 | |

Table B-7: Sequential Turntable and Carousel Parts

| Part | Number | Additional Information |
|--|-------------|--|
| Carousel, 24 x 500 mL | WW160 | bottle locator |
| | WW394 | plastic tub |
| | WW203 | aluminum base |
| | WW210 | handle bracket |
| | WW212 | handle |
| Carousel, 24 x 1000 mL | WW404 | bottle locator |
| | WW395 | plastic tub |
| | WW204 | aluminum base |
| | WW406 | handle bracket |
| | WW212 | handle |
| Carousel Assembly, 24x500 | SEQ-500 | include carousel, 24 bottles with caps, and bottle locator |
| Carousel Assembly, 24x1000 | SEQ-24-1000 | |
| Turntable Drive, Complete | WW198 | |
| Turntable Drive Bearing Ring | WW205 | |
| Turntable Drive Block | WW206 | |
| Turntable Drive Motor, 120 VAC | WW084 | |
| Turntable Drive Sensor | WW341 | each drive is equipped with 2 |
| Turntable Drive Top Plate Top Plate Magnets | WW163 | preassembled if ordered together 24 magnets required |
| | WW342 | |

Table B-8: Sample Containers and Bottles

| Part | Number | Additional Information |
|-----------------------------------|--------|------------------------|
| Bottle, 500 mL LDPE | WW218 | includes cap |
| Bottle, Wedge, 1000 mL LDPE | WW214 | includes cap |
| Bottle, 2.5 Gallon Glass | WW220 | includes cap |
| Bottle, 2.5 Gallon LDPE | WW201 | includes cap |
| Bottle, 5.5 Gallon LDPE | WW202 | includes cap |
| Container, 3.0 Gallon HDPE Lid | WW179 | |
| | WW194 | |
| Container, 5.0 Gallon HDPE Lid | WW177 | |
| | WW178 | |

Appendix C: Specifications

| | |
|------------------------|--|
| Height/Width/Depth : | Optima: 49 x 25.5 x 25.5 in (125 x 65 x 65 cm) Premium: 53.2 x 31 x 33 in (135 x 79 x 84 cm) |
| Weight : | Optima: 190 lb (41 kg) Premium: 240 lb (110 kg) |
| Power Requirements : | 115 VAC, 60 Hz standard; 9.2 A maximum 230 VAC, 50 Hz is available as an option |
| Ambient Temperatures : | 32 to 122 °F (0 to 50°C) standard, or -20 to 122 °F (-29 to 50°C) with optional heater |
| Cabinet Insulation : | Sample compartment fully insulated with 2.5 in (6.3 cm) polystyrene |
| Corrosion Protection : | Refrigeration module copper lines are phenolic coated |
| Container Options : | 10 or 20 liter LDPE bottle 2 or 3 gallon HDPE container 2.5 gallon glass bottle Carousel with twenty-four 500 ml or 1000 ml bottles Carousel with two 10 liter or 2 or 3 gallon containers Premium only: Carousel with four 10 liter or 2 or 3 gallon containers |
| Intake Tubing : | 3/8 in I.D. clear vinyl |
| Maximum Lift : | 23 ft (7 m) standard, or 28 ft (8.6 m) with optional quick-lift pump Measured from top of sample chamber (3.5 feet above floor) |
| Line Velocity : | Greater than 2.25 ft/s (0.7 m/s) @ 20 foot lift Exceeds EPA requirements |
| Sample Size : | 15 to 400 ml |
| Repeatability : | 5 milliliters |
| Controller : | Custom microprocessor logic & input/output circuit boards |

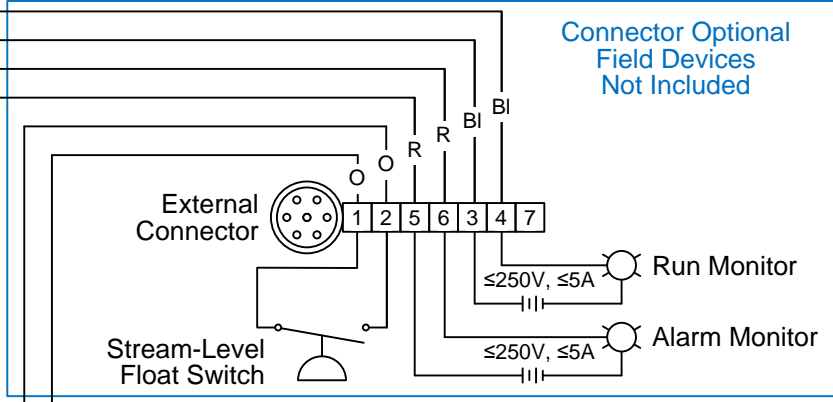
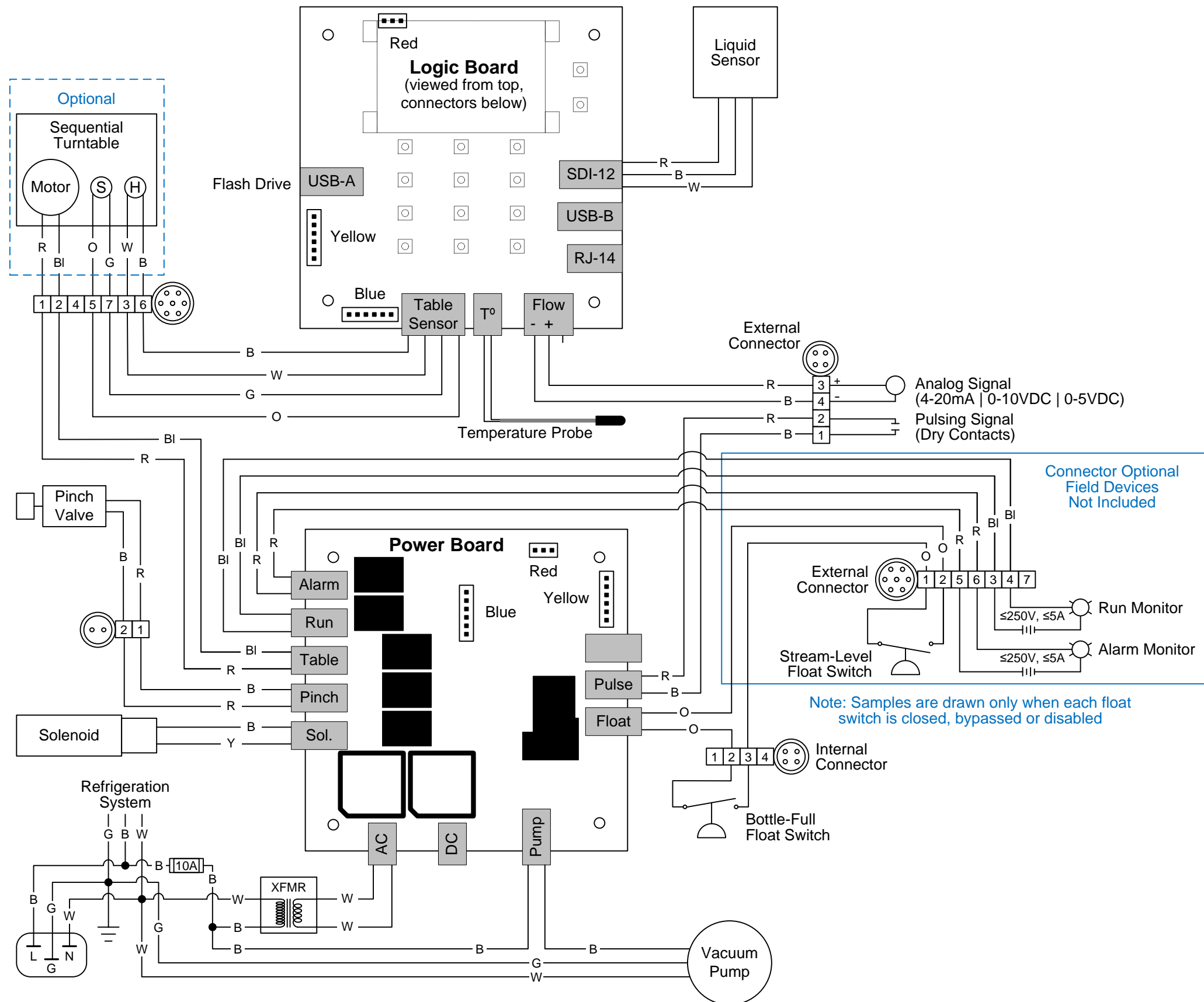

Note: Samples are drawn only when each float switch is closed, bypassed or disabled